

DVD Palmcorder®
CAMCORDER

Panasonic®

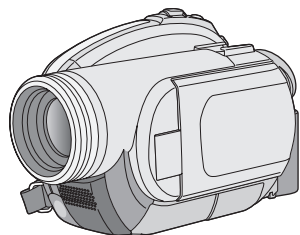

Operating Instructions DVD Video Camera

Model No. **VDR-D220**

Before connecting, operating or adjusting this product, please read the instructions completely. Spanish Quick Use Guide is included. Guía para rápida consulta en español está incluida.



For USA assistance, please call: 1-800-211-PANA(7262) or, contact us via the web at: <http://www.panasonic.com/contactinfo>

For Canadian assistance, please call: 1-800-561-5505 or visit us at www.panasonic.ca



LSQT1146 A

Things You Should Know

Thank you for choosing Panasonic!

You have purchased one of the most sophisticated and reliable products on the market today. Used properly, we're sure it will bring you and your family years of enjoyment. Please take time to fill in the information on the right.

Be sure to **retain this manual** as your convenient camera information source.

Date of Purchase _____

Dealer Purchased From _____

Dealer Address _____

Dealer Phone No. _____

Model No. _____



Serial No. _____

Safety Precautions

CAUTION: DANGER OF EXPLOSION IF BATTERY IS INCORRECTLY REPLACED. REPLACE ONLY WITH THE SAME OR EQUIVALENT TYPE.

CAUTION: USE OF CONTROLS OR ADJUSTMENTS OR PERFORMANCE OF PROCEDURES OTHER THAN THOSE SPECIFIED HEREIN MAY RESULT IN HAZARDOUS RADIATION EXPOSURE.

The following mark and symbols are located on bottom of the unit.

	CAUTION RISK OF ELECTRIC SHOCK DO NOT OPEN	
CAUTION: TO REDUCE THE RISK OF ELECTRIC SHOCK, DO NOT REMOVE SCREWS. NO USER-SERVICEABLE PARTS INSIDE. REFER SERVICING TO QUALIFIED SERVICE PERSONNEL.		



The lightning flash with arrowhead symbol, within an equilateral triangle, is intended to alert the user to the presence of uninsulated "dangerous voltage" within the product's enclosure that may be of sufficient magnitude to constitute a risk of electric shock to persons.



The exclamation point within an equilateral triangle is intended to alert the user to the presence of important operating and maintenance (servicing) instructions in the literature accompanying the appliance.

WARNING:

TO REDUCE THE RISK OF FIRE, ELECTRIC SHOCK OR PRODUCT DAMAGE,

- DO NOT EXPOSE THIS APPARATUS TO RAIN, MOISTURE, DRIPPING OR SPLASHING AND THAT NO OBJECTS FILLED WITH LIQUIDS, SUCH AS VASES, SHALL BE PLACED ON THE APPARATUS.
- USE ONLY THE RECOMMENDED ACCESSORIES.
- DO NOT REMOVE THE COVER (OR BACK); THERE ARE NO USER SERVICEABLE PARTS INSIDE. REFER SERVICING TO QUALIFIED SERVICE PERSONNEL.

CAUTION!

DO NOT INSTALL OR PLACE THIS UNIT IN A BOOKCASE, BUILT-IN CABINET OR IN ANOTHER CONFINED SPACE. ENSURE THE UNIT IS WELL VENTILATED. TO PREVENT RISK OF ELECTRIC SHOCK OR FIRE HAZARD DUE TO OVERHEATING, ENSURE THAT CURTAINS AND ANY OTHER MATERIALS DO NOT OBSTRUCT THE VENTILATION VENTS.

**CLASS 1
LASER PRODUCT**

IEC 60825-1:2001

CAUTION

This product contains a laser diode of higher class than 1. To ensure continued safety, do not remove any covers or attempt to gain access to the inside of the product. Refer all servicing to qualified personnel.

⚠ WARNING

- **AS WITH ANY SMALL OBJECT, SD CARDS CAN BE SWALLOWED BY YOUNG CHILDREN. DO NOT ALLOW CHILDREN TO HANDLE THE SD CARD.**

THE FOLLOWING APPLIES ONLY IN THE U.S.A.

FCC Note: This equipment has been tested and found to comply with the limits for a Class B digital device, pursuant to Part 15 of the FCC Rules. These limits are designed to provide reasonable protection against harmful interference in a residential installation. This equipment generates, uses, and can radiate radio frequency energy and, if not installed and used in accordance with the instructions, may cause harmful interference to radio communications. However, there is no guarantee that interference will not occur in a particular installation. If this equipment does cause harmful interference to radio or television reception, which can be determined by turning the equipment off and on, the user is encouraged to try to correct the interference by one or more of the following measures:

- Reorient or relocate the receiving antenna.
- Increase the separation between the equipment and receiver.
- Connect the equipment into an outlet on a circuit different from that to which the receiver is connected.
- Consult the dealer or an experienced radio/TV technician for help.

FCC Caution: To assure continued compliance, follow the attached installation instructions and use only shielded interface cables with ferrite core when connecting to computer or peripheral devices. Any changes or modifications not expressly approved by the party responsible for compliance could void the user's authority to operate this equipment.

Declaration of Conformity

Trade Name: Panasonic
Model No.: VDR-D220
Responsible party: Panasonic Corporation of North America
One Panasonic Way, Secaucus, NJ 07094
Support Contact: Panasonic Consumer Electronics Company
1-800-211-PANA (7262)

This device complies with Part 15 of the FCC Rules. Operation is subject to the following two conditions: (1) This device may not cause harmful interference, and (2) this device must accept any interference received, including interference that may cause undesired operation.

Panasonic VDR-D220



Tested To Comply
With FCC Standards

FOR HOME OR OFFICE USE

THE FOLLOWING APPLIES ONLY IN CANADA

This Class B digital apparatus complies with Canadian ICES-003.

IMPORTANT SAFETY INSTRUCTIONS

Read these operating instructions carefully before using the unit. Follow the safety instructions on the unit and the applicable safety instructions listed below. Keep these operating instructions handy for future reference.

- 1) Read these instructions.
- 2) Keep these instructions.
- 3) Heed all warnings.
- 4) Follow all instructions.
- 5) Do not use this apparatus near water.
- 6) Clean only with dry cloth.
- 7) Do not block any ventilation openings. Install in accordance with the manufacturer's instructions.
- 8) Do not install near any heat sources such as radiators, heat registers, stoves, or other apparatus (including amplifiers) that produce heat.
- 9) Do not defeat the safety purpose of the polarized or grounding-type plug. A polarized plug has two blades with one wider than the other. A grounding type plug has two blades and a third grounding prong. The wide blade or the third prong are provided for your safety. If the provided plug does not fit into your outlet, consult an electrician for replacement of the obsolete outlet.
- 10) Protect the power cord from being walked on or pinched particularly at plugs, convenience receptacles, and the point where they exit from the apparatus.
- 11) Only use attachments/accessories specified by the manufacturer.
- 12) Use only with the cart, stand, tripod, bracket, or the table specified by the manufacturer, or sold with the apparatus. When a cart is used, use caution when moving the cart/apparatus combination to avoid injury from tip-over.
- 13) Unplug this apparatus during lightning storms or when it will be left unused for long periods of time.
- 14) Refer all servicing to qualified service personnel. Servicing is required when the apparatus has been damaged in any way, such as when the power-supply cord or plug is damaged, liquid has been spilled or objects have fallen into the apparatus, the apparatus has been exposed to rain or moisture, does not operate normally, or has been dropped.



Precautions

USE & LOCATION

WARNING

- **TO AVOID SHOCK HAZARD ...** Your camera and power supply should not be exposed to rain or moisture. Do not connect the power supply or operate your camera if it gets wet. Your camera has been designed for outdoor use, however it is not designed to sustain direct exposure to water, rain, sleet, snow, sand, dust, or a direct splashing from a pool or even a cup of coffee. This action could permanently damage the internal parts of your camera. Do not attempt to disassemble this unit. There are no user serviceable parts inside. Unplug your camera from the power supply before cleaning.

CAUTION

- **DO NOT AIM YOUR CAMERA AT THE SUN OR OTHER BRIGHT OBJECTS**
- **DO NOT LEAVE THE CAMERA WITH THE EVF AIMED DIRECTLY AT THE SUN AS THIS MAY CAUSE DAMAGE TO THE INTERNAL PARTS OF THE EVF**
- **DO NOT EXPOSE YOUR CAMERA TO EXTENDED HIGH TEMPERATURE ...** Such as, in direct sunlight, inside a closed car, next to a heater, etc... This action could permanently damage the internal parts of your camera.

■ **Indemnity concerning recording content**

The manufacturer shall in no event be liable for the loss of recordings due to malfunction or defect of this unit, its accessories or recordable media.

IMPORTANT

■ **Carefully observe copyright laws**

Whatever you have recorded and created can be used for your personal entertainment only. Under copyright laws, other materials cannot be used without obtaining permission from the holders of the copyrights.

- **AVOID SUDDEN CHANGES IN TEMPERATURE ...** If the unit is suddenly moved from a cold place to a warm place, moisture may form on the disc and inside the unit.
- **DO NOT LEAVE YOUR CAMERA OR THE POWER SUPPLY TURNED ON WHEN NOT IN USE.**
- **STORAGE OF YOUR CAMERA ...** Store and handle your camera in a manner that will not subject it to unnecessary movement (avoid shaking and striking). Your camera contains a sensitive pick-up device which could be damaged by improper handling or storage.

CARE

- **TO CLEAN YOUR CAMERA ...** Do not use strong or abrasive detergents when cleaning your camera body.
- **TO PROTECT THE LENS ...** Do not touch the surface of the lens with your hand. Use a commercial camera lens solution and lens paper when cleaning the lens. Improper cleaning can scratch the lens coating.
- **TO PROTECT THE FINISH OF YOUR CAMERA ...** Before handling your camera, make sure your hands and face are free from any chemical products, such as suntan lotion, as it may damage the finish.

Battery pack (Lithium ion battery pack)

- Use the specified unit to recharge the battery pack.
- Do not use the battery pack with equipment other than the specified unit.
- Do not get dirt, sand, liquids, or other foreign matter on the terminals.
- Do not touch the plug terminals (+ and -) with metal objects.
- Do not disassemble, remodel, heat or throw into fire.

If any electrolyte should come into contact with your hands or clothes, wash it off thoroughly with water.

If any electrolyte should come into contact with your eyes, never rub the eyes. Rinse eyes thoroughly with water, and then consult a doctor.

Warning

Risk of fire, explosion and burns. Do not disassemble, heat above 60 °C (140 °F) or incinerate.

AC adaptor

This AC adaptor operates on AC between 110/120/220/240 V.

But

- In the U.S.A. and Canada, the AC adaptor must be connected to a 120 V AC power supply only.
- When connecting to an AC supply outside of the U.S.A. or Canada, use a plug adaptor to suit the AC outlet configuration.
- When connecting to a supply of greater than AC 125 V, ensure the cord you use is suited to the voltage of the AC supply and the rated current of the AV adaptor.
- Contact an electrical parts distributor for assistance in selecting a suitable AC plug adaptor or AC cord set.

The socket outlet shall be installed near the equipment and easily accessible. The mains plug of the power supply cord shall remain readily operable. To completely disconnect this apparatus from the AC Mains, disconnect the power supply cord plug from AC receptacle.

U.S.A./CANADA CONSUMERS: ATTENTION:



A lithium ion/polymer battery that is recyclable powers the product you have purchased. Please call 1-800-8-BATTERY for information on how to recycle this battery.

-If you see this symbol-



Information on Disposal in other Countries outside the European Union

This symbol is only valid in the European Union.

If you wish to discard this product, please contact your local authorities or dealer and ask for the correct method of disposal.

- SDHC Logo is a trademark.
- miniSD Logo is a trademark.
- Apparatus Claims of U.S. Patent Nos. 4,631,603, 4,577,216, and 4,819,098, licensed for limited viewing.

This product incorporates copyright protection technology that is protected by method claims of certain U.S. patents and other intellectual property rights owned by Macrovision Corporation and other rights owners. Use of this copyright protection technology must be authorized by Macrovision Corporation, and is intended for home and other limited viewing uses only unless otherwise authorized by Macrovision Corporation. Reverse engineering or disassembly is prohibited.

- Manufactured under license from Dolby Laboratories.
"Dolby" and the double-D symbol are trademarks of Dolby Laboratories.
- Microsoft® and Windows® are either registered trademarks or trademarks of the Microsoft Corporation in the United States and/or other countries.
- IBM and PC/AT are registered trademarks of International Business Machines Corporation of the U.S.
- Intel® and Pentium® are the registered trademarks or trademarks of the Intel Corporation in the United States and other countries.
- Microsoft product screen shot(s) reprinted with permission from Microsoft Corporation.
- Other names of systems and products mentioned in these instructions are usually the registered trademarks or trademarks of the manufacturers who developed the system or product concerned.

Contents

Before using

Features	10
Quick Guide	12
Accessories	15
Parts identification and handling	15
Using the LCD monitor	18
Using the viewfinder	18
Discs and cards	19
Discs that can be used on this unit	19
Cards that you can use with this unit	23
Disc and card handling	24

Setup

Power supply	25
Charging the battery	25
Connecting to the AC outlet	28
Turning the unit on/off	28
Inserting/removing a disc	29
Inserting/removing an SD card	31
Selecting a mode	32
How to use the joystick	32
Switching the language	36
Using the menu screen	36
Setting date and time	38
Adjusting LCD monitor/viewfinder	39

Recording

Before recording	40
Recording motion pictures	42
Recording modes and recordable time available for the motion picture	43
Recording still pictures (JPEG still pictures)	45
Number of pixels and picture quality for still picture recording	46
Various recording functions	48
Zoom in/out function	48
Recording yourself	49
Recording with the video light	49
Backlight compensation function	50
Fade in/fade out function	50
Soft skin mode	51
MagicPix function	51

Self-timer recording	52
Recording guideline function	52
Wide mode	53
Image stabilizer function	53
Wind noise reduction function	54
Manual recording functions	54
Scene mode	54
Manual focus adjustment	55
White balance	56
Manual shutter speed/ aperture adjustment	57

Playback

Motion picture playback	59
Still picture playback (JPEG still pictures)	62

Editing

Editing scenes	64
Deleting scenes	64
Dividing a scene	65
Combining scenes	65
Using playlists	66
What is a playlist?	66
Creating a new playlist	66
Playing back a playlist	67
Editing a playlist	67
Editing still pictures	71
Deleting still pictures	71
Locking still pictures	72
DPOF setting	72

Disc and card management

Disc management	74
Finalizing a disc	74
Un-finalizing a DVD-RW	75
Protecting a disc	75
Formatting discs	75
Displaying disc information	76
Card management	76
Formatting an SD card	76

With other products

With a TV	78
Playback on TV	78

With a DVD recorder/player.....	79
Playback on DVD recorder, DVD player, computer etc.....	79
Copying (dubbing) recordings onto a DVD recorder's hard disk	79
With a VCR.....	80
Recording (dubbing) images onto other video devices	80
With a printer (PictBridge).....	81

With a computer

Before using with a computer.....	83
Contents on provided CD-ROM	83
Operating environment.....	83
End User License Agreement	84
Installation	84
Installing DVD-RAM Driver.....	85
Reading the operating instructions of the software applications.....	86
Software application uninstallation	86
Connection and recognition	87
Connection and recognition procedures..	87
About the computer display.....	88
To disconnect USB cable safely	89
Verifying the unit is correctly recognized by the computer.....	89

Others

Menus.....	91
Menu list.....	91
Other menus.....	92
Indications	93
Indications	93
Messages	96
Functions that cannot be used simultaneously	98
Frequently asked questions.....	99
Troubleshooting	100
Cautions for use.....	105
Explanation of terms.....	108
Specifications.....	110
Number of recordable pictures on an SD card	112
Optional accessories.....	113
Accessory Order Form (For USA Customers).....	114

Request for Service Notice (USA Only)	115
Limited Warranty (For USA Customers).....	116
Customer Services Directory.....	117
Warranty (For Canadian Customers).....	118
Index.....	119
Spanish Quick Use Guide/ Guía española para el uso rápido.....	121

Features

■ Easy recording! (→ 42)

No need to search for the recording start position.

The new recording will not overwrite any previously recorded scene.

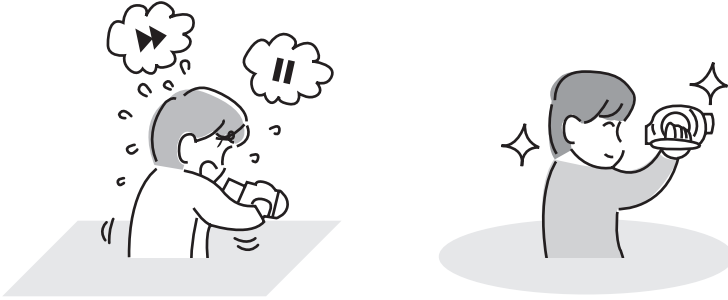

■ Easy playback! (→ 59)

Recorded scenes are displayed as thumbnails.

You can easily search for the scenes you want to watch.

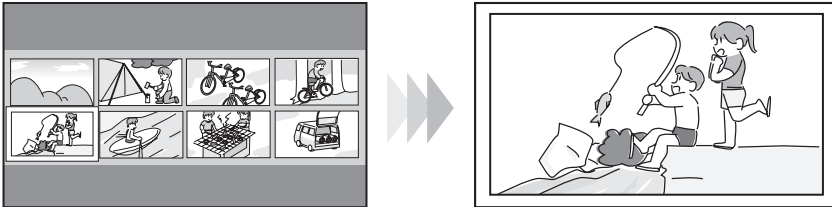

■ Editing scenes! (→ 64, 66)

You can create an original video (playlist) by collecting your favorite scenes together and then easily record (dub) this video to a VCR or a DVD recorder.

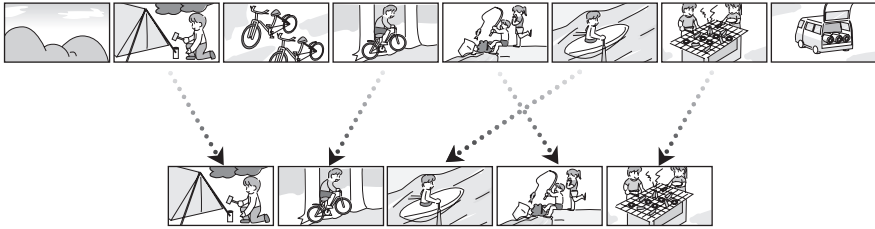

If you insert a DVD-RW or a DVD-R disc recorded in this unit (that has not been finalized) into another device such as DVD recorder, computer, etc., the disc may become unusable. Be sure to finalize the disc on this unit before inserting it in other devices. (→ 74)

■ Using with DVD player/recorder! (→ 79)

Just insert the disc into a DVD player/recorder compatible with 8 cm (3") discs to play back the scenes recorded with this unit.

If you have a DVD recorder with hard disk, you can copy (dub) scenes recorded on a disc with this unit to the hard disk.

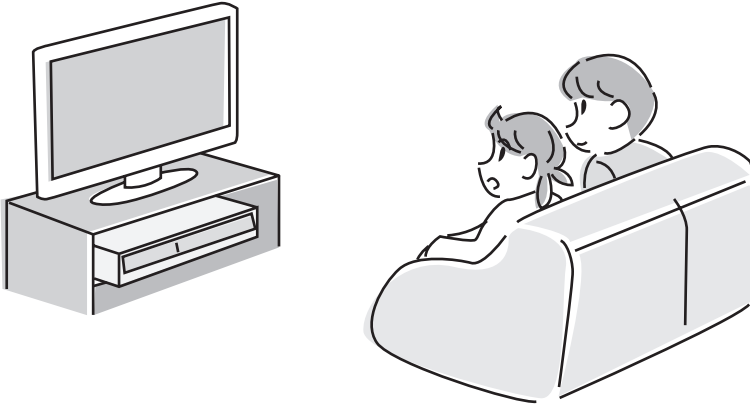

Quick Guide

■ Charging the battery

- 1 Connect the AC cable to the AC adaptor and the AC outlet.
- 2 Put the battery on the battery mount by aligning the mark, and then securely plug it in.

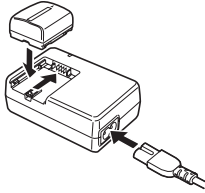

■ Inserting the battery

Push the battery against the battery holder and slide it until it clicks.

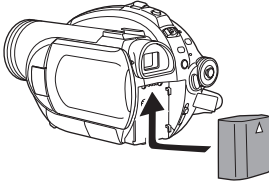

■ Removing the battery

While sliding the BATTERY lever, slide the battery to remove it.

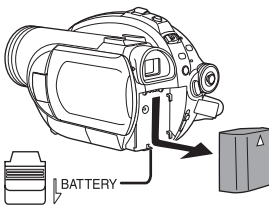

■ How to turn on/off the power

While pressing the button **A**, set the OFF/ON switch to ON/OFF.

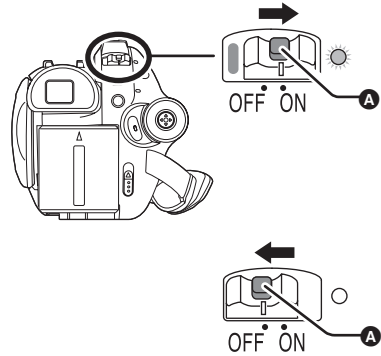

■ Inserting/removing a disc

- 1 Slide the DISC EJECT lever once and release it.

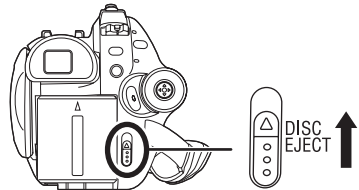

- 2 Open the cover of the disc compartment by hand and insert/remove the disc.

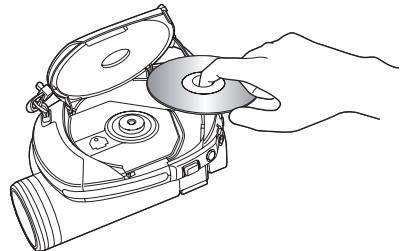

- 3 Push the section marked PUSH CLOSE on the cover of the disc compartment to close the cover.

■ Inserting/removing an SD card

- 1 Slide the card slot cover to open.

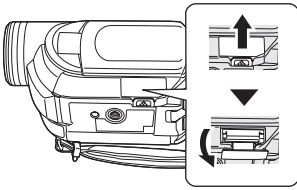

- 2 Insert/remove the SD card into/from the card slot.

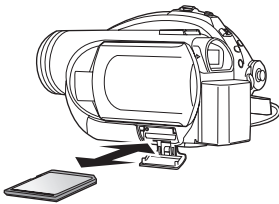

- 3 Securely close the card slot cover.

■ Recording motion pictures

- Rotate the mode dial to select .

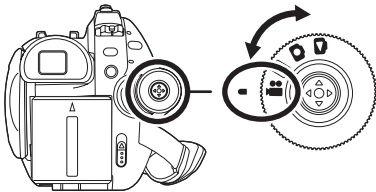

- 1 Press the recording start/stop button to start recording.

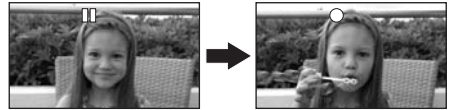
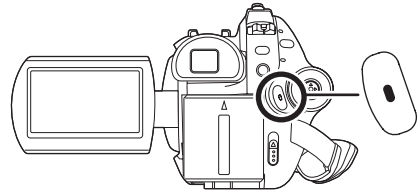

- 2 Press the recording start/stop button again to pause recording.

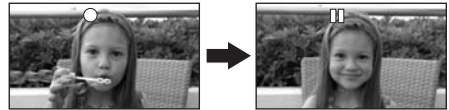

■ Recording still pictures (JPEG still pictures)

- Rotate the mode dial to select .

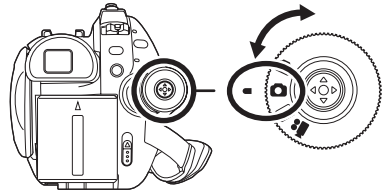

Press the Photoshot button [].

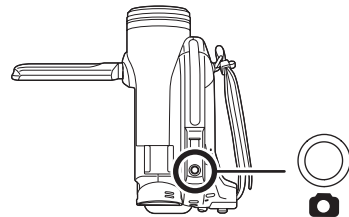

■ Motion picture playback

- Rotate the mode dial to select .

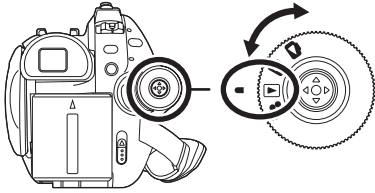

- 1 Select the scene to be played back.

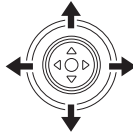





- 2 Press the joystick.

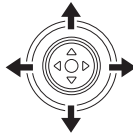

- 3 Move the joystick to operate.



- : Playback/Pause
- : Skip playback (backward)
- : Skip playback (forward)
- : Stops the playback and shows the thumbnails.

■ Still picture playback (JPEG still pictures)

- Rotate the mode dial to select .

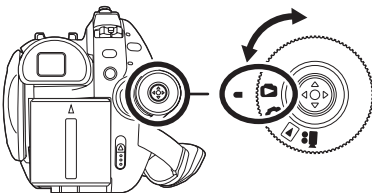

- 1 Select the file to be played back.

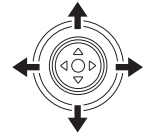





- 2 Press the joystick.

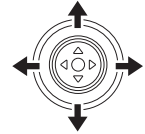

- 3 Move the joystick to operate.



- : Slide show start/pause.
- : Plays back the previous picture.
- : Plays back the next picture.
- : Stops the playback and shows the thumbnails.

Accessories

Check the accessories before using this unit.

Battery pack
CGR-DU06



AC adaptor
PV-DAC14D



AC cable
K2CA2CA00029 or
K2CA2CA00025



DC cable
K2GJ2DC00011



AV/S cable
K2KZ9CB00001



Lens cap
LSYK2004



USB cable
K1HA05CD0014



CD-ROM
LSFT0721



**8 cm (3") DVD-RAM disc
(Single sided)**
LM-AF30UB



Parts identification and handling

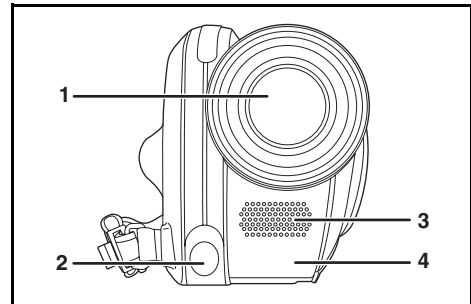

- 1 Lens
- 2 Video light (→ 49)
- 3 Microphone (built-in, stereo)
- 4 White balance sensor (→ 56)

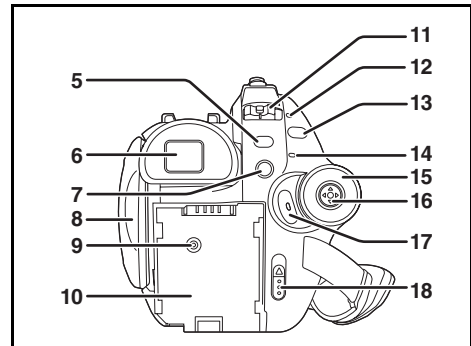

- 5 Menu button [MENU] (→ 36)
- 6 Viewfinder (→ 18)

Due to limitations in LCD production technology, there may be some tiny bright or dark spots on the viewfinder screen. However, this is not a malfunction and does not affect the recorded picture.

- 7 Delete button [] (→ 64, 68, 71)
- 8 LCD monitor open part (→ 18)
- 9 DC input terminal [DC/C.C. IN] (→ 28)
- 10 Battery holder (→ 25)
- 11 Power switch [OFF/ON] (→ 28)
- 12 Status indicator (→ 28)
- 13 Video light button [LIGHT] (→ 49)
- 14 Disc/computer access lamp [ACCESS/PC] (→ 29, 87)
- 15 Mode dial (→ 32)

- 16 Joystick (→ 32)
- 17 Recording start/stop button (→ 42)
- 18 Disc eject lever [DISC EJECT] (→ 29)

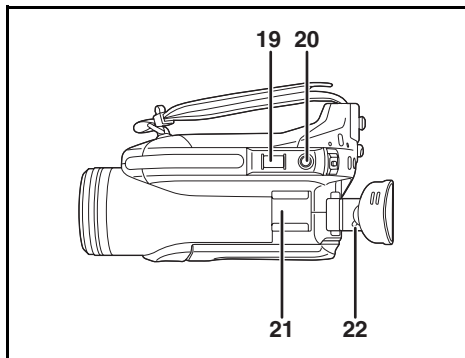

- 19 When recording: Zoom lever [W/T] (→ 48)
When playing back: Volume lever [-VOL+] (→ 60)
- 20 Photoshot button [] (→ 45)
- 21 Accessory shoe
 - Accessories, such as a video DC light (optional), are attached here.
- 22 Eyepiece corrector knob (→ 39)

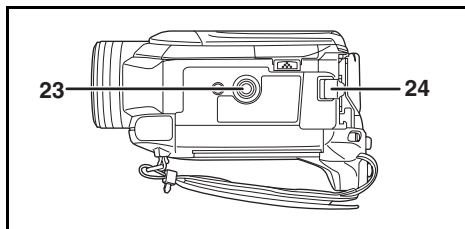

- 23 Tripod receptacle (→ 18)
- 24 Battery release lever [BATTERY] (→ 25)

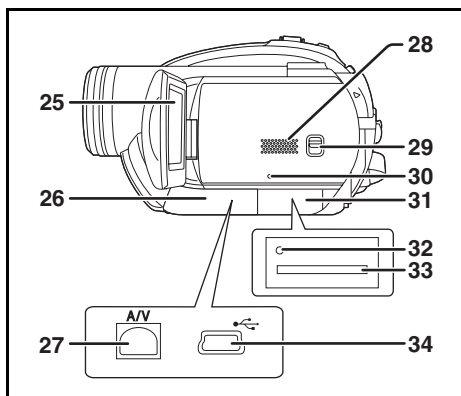

- 25 LCD monitor (→ 18)

Due to limitations in LCD production technology, there may be some tiny bright or dark spots on the LCD monitor screen. However, this is not a malfunction and does not affect the recorded picture.

- 26 Terminal cover
- 27 Audio-video output terminal [A/V] (→ 78, 80)
- 28 Speaker
- 29 Mode select switch [AUTO/MANUAL/ FOCUS] (→ 41, 54, 55)
- 30 Reset button [RESET] (→ 103)
- 31 Card slot cover [SD CARD] (→ 31)
- 32 Card access lamp (→ 32)
- 33 Card slot (→ 31)
- 34 USB terminal [] (→ 81, 87)

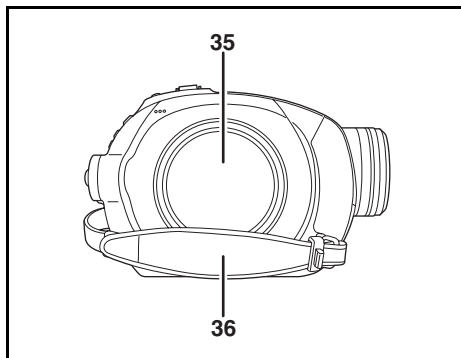

- 35 Disc compartment (→ 29)
- 36 Grip belt (→ 17)

Using grip belt

Adjust the belt length so it fits your hand.

Adjust the belt length and the pad position.

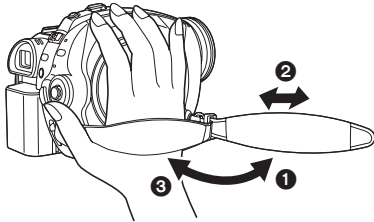

- ❶ Flip the belt.
- ❷ Adjust the length.
- ❸ Replace the belt.

Attaching the lens cap

Attach the lens cap to protect the surface of the lens.

- 1** Pass the end of the lens cap cord through the belt.

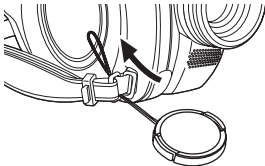

- 2** Pass the lens cap through the loop.

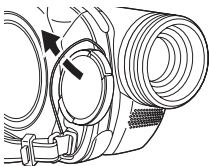

- 3** To attach or remove the lens cap, hold both sides of the lens cap

with the tips of your finger and thumb.

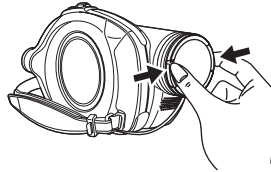

During recording

The removed lens cap can be attached to the lens cap fixture.

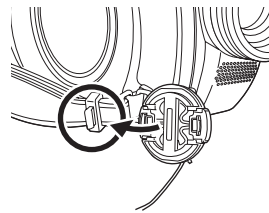

Lens hood

Rotate the lens hood counter-clockwise **A** to remove it. In order to attach it, rotate it clockwise **B**.

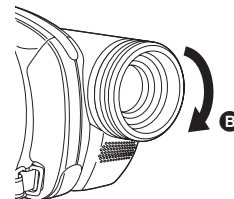
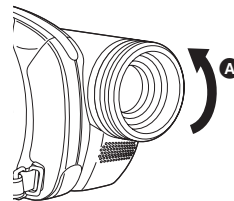

Tripod receptacle

This is a hole for attaching the unit to the optional tripod.

(Please carefully read the operating instructions for how to attach the unit to the tripod.)

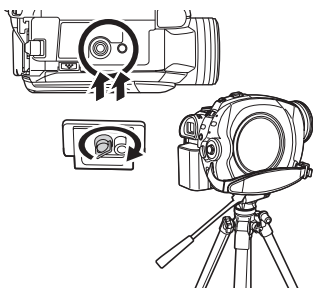

- When the tripod is used, the card slot cover cannot be opened. Insert an SD card before attaching this unit to the tripod. (→ 31)

Using the LCD monitor

You can record the image while viewing it on the LCD monitor.

- 1 Place your finger on the LCD monitor open part **A** and pull the LCD monitor out in the direction of the arrow.**

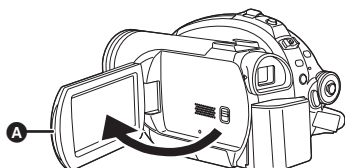

- It can open up to 90°.

- 2 Adjust the angle of the LCD monitor as desired.**

- It can rotate up to 180° **A** towards the lens or 90° **B** towards the viewfinder.

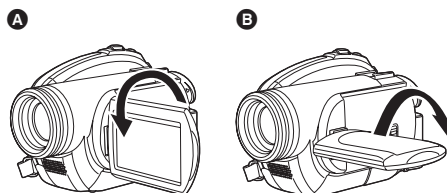

- The brightness and color level of the LCD monitor can be adjusted from the menu. (→ 39)
- The unit may be damaged or fail if the LCD monitor is forcibly opened or rotated.
- If the LCD monitor is rotated by 180° towards the lens and the viewfinder is extended (when recording yourself), the LCD monitor and the viewfinder simultaneously light.

Using the viewfinder

Pull out the viewfinder.

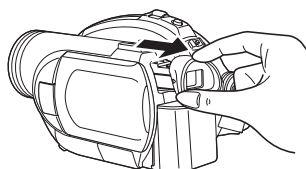









The viewfinder will be activated. (If the LCD monitor is opened, the viewfinder will be deactivated.)





- The brightness of the viewfinder (→ 39) and the field of view (→ 39) can be adjusted.

Discs and cards

Discs that can be used on this unit

Disc type	DVD-RAM 8 cm (3") Single sided/ double sided	DVD-RW 8 cm (3") Single sided/double sided	
	 (DVD-RAM Ver. 2.1)	 [DVD-RW Ver. 1.1/2X-SPEED (2X/1X)]	
Recording format	DVD Video Recording format (VR format)	DVD Video Recording format (VR format)	DVD-Video format (Video format)
Characteristic	Rewritable disc	Rewritable disc	One time recording disc ^{*1}
Display on the screen			
Indication in these instructions			
Functions			
• Deleting recorded scenes	●	●	—
• Editing on this unit	●	●	—
• Playback on other products ^{*2}	● ^{*3}	● ^{*4}	● ^{*5}
• Recording after finalizing	—	●	● ^{*6}

Before using

Disc type	DVD-R 8 cm (3") Single sided/double sided	DVD-R DL 8 cm (3") Dual layer on single side
		 (DVD-R for General Ver. 2.0)
Recording format	DVD-Video format (Video format)	DVD-Video format (Video format)
Characteristic	One time recording disc	One time recording disc
Display on the screen		
Indication in these instructions		
Functions		
• Deleting recorded scenes	—	
• Editing on this unit	—	
• Playback on other products*2	●*5	
• Recording after finalizing	—	

●: available —: not available

*1 By formatting the disc, it can be used repeatedly. (→ 75)

*2 DVD players and DVD recorders that support 8 cm (3") discs.

*3 Playback is possible on compatible products.

*4 Must be finalized on this unit. (→ 74) Playback is possible on compatible products.

*5 Must be finalized on this unit. (→ 74) Playback of DVD-R DL is possible on compatible products.

*6 Un-finalize the disc. (→ 75)

- For the purposes of these operating instructions, DVD-R and DVD-R DL are referred to as the "DVD-R".
- **Still pictures cannot be recorded on a disc with this unit.**
- You cannot record or play continuously from one side of the disc to the other when using a double sided disc. You will need to eject the disc and turn it over.
- Discs inserted in a holder, cartridge, or caddy case cannot be used. Always remove bare discs from these containers prior to use.
- It is recommended that you use Panasonic discs. Usually discs compatible with the DVD standard can be used for recording and playback with no problems. However, some commercially available discs do not meet the DVD standard for quality and performance. If you use one of these discs, you may not be able to record or playback normally. (The message "RECOMMENDED TO USE PANASONIC DISC" appears.) Refer to the following support site for information about discs that have been confirmed as compatible by Panasonic.
http://panasonic.co.jp/pavc/global/cs/e_cam (This website is in English only.)
- **Discs recorded on this unit may not be playable on other products.**
- Recording on DVD-R in DVD Video Recording format is not supported.
- **When using DVD-RW or DVD-R, do not perform the following as it may make the disc unusable.**
 - Record on a disc with other products after recording on it with this unit.
 - Record on a disc with this unit after recording on it with other products.
 - Insert an un-finalized disc in any other products.

■ About format types

What is the DVD Video Recording format (VR format)?

This is a format for recording on DVD discs which allows you to record and erase repeatedly and create playlists. You can record on DVD-RAM and DVD-RW in VR format with this unit.

What is the DVD-Video format (Video format)?

By finalizing the disc, it can be played back on most DVD players. You can record on DVD-RW and DVD-R in Video format with this unit.

■ About DVD-R DL (Dual Layer)

DVD-R DL (Dual Layer) discs have two layers of recording/playback surface on one side. If the first layer (L0) becomes full during recording, the recording continues uninterrupted on the second layer (L1). However, the recorded picture is divided into 2 scenes at the point where the layers switch. The unit automatically switches layers during disc playback so you can play the whole of the disc continuously like a normal disc. However, the image or sound momentarily stop at the point where the layers switch.

■ Examples of discs that cannot be used on this unit

- Discs other than those with diameter of 8 cm (3")
- Double layer discs other than DVD-R DL
- +RW
- +R
- DVD-ROM
- DVD-Video
- CD-RW
- CD-R
- CD-ROM
- CD

When using brand-new DVD-RW

When using DVD-RW, select whether to record in DVD Video Recording format (VR format) or DVD-Video format (Video format) and then format the disc. (→ 21, About format types)

- 1** When a brand-new DVD-RW is inserted in this unit, the screen on the right appears. Select [YES], then press the joystick.

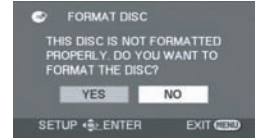

- 2** Select format type, then press the joystick.

[VIDEO]: DVD-Video format

[VR]: DVD Video Recording format



- 3** When the confirmation message appears, select [YES], then press the joystick.

- To change the format type, format the disc again. (→ 75)
If the disc is formatted, then all the data recorded on the disc will be erased.

Cards that you can use with this unit

Card type	SD Memory Card	SDHC Memory Card
Capacity	8 MB, 16 MB, 32 MB, 64 MB, 128 MB, 256 MB, 512 MB, 1 GB, 2 GB	4 GB
Indication in these instructions	SD	

This unit is compatible with both SD Memory cards and SDHC Memory cards. You can only use SDHC Memory cards on devices that are compatible with them. You cannot use SDHC Memory cards on devices that are only compatible with SD Memory cards. (When using an SDHC Memory card on another device, be sure to read the operating instructions for that device.)

- For the purposes of these operating instructions, SD Memory Card and SDHC Memory Card are referred to as the “SD card”.
- **Motion pictures cannot be recorded on an SD card with this unit.**
- Please confirm the latest information on the following website. (This website is in English only.)
http://panasonic.co.jp/pavc/global/cs/e_cam
- This unit supports SD Memory Cards formatted in FAT12 system and FAT16 system based on SD Memory Card Specifications and SDHC Memory Cards formatted in FAT32 system.
- Use this unit to format SD cards. If an SD card is formatted on other products (such as a computer), the time spent for recording may become longer and you may not be able to use the SD card. (→ 76)
- We recommend that you use a Panasonic brand SD card.
- When the write-protect switch **A** on SD card is locked, no recording, deletion or editing will be possible on the card.
- Keep the Memory Card out of reach of children to prevent swallowing.
- A MultiMediaCard cannot be used on this unit.

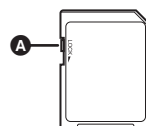

Disc and card handling

■ How to hold a disc or card

Do not touch the recording/playback surface or the terminal surface.



■ When inserting/removing a disc

Do not allow the recording/playback side of the disc to get dirty and avoid fingerprints.

- If there is a scratch or dirt (e.g. dust or fingerprints) on the recording/playback side of the disc, images cannot be recorded or played back normally and the following phenomena may occur:
 - Recording or playback becomes impossible.
 - Playback image stops momentarily or sound is interrupted during playback.
 - Block noise appears on playback images.
 - The message “PLEASE CHECK FOR SCRATCHES OR STAINS ON DISC.” appears.

■ If there is dirt or condensation on the disc

Wipe with a damp cloth and then wipe dry.



■ Handling precautions

- Be careful about scratches and dirt.
- Do not attach labels or stickers to discs.
(This may cause disc warping and un-balanced rotation, rendering it unusable.)
- Write on the label side of the disc only with a soft, oil-based felt pen. Do not use ballpoint pens or other hard writing implements.
- Do not use record cleaning sprays, benzene, thinner, static electricity prevention liquids or any other solvent.
- Do not use scratch-proof protectors or covers.
- Do not drop, stack, or impact discs. Do not place objects on them.
- Do not use the following discs:
 - Discs with exposed adhesive from removed stickers or labels.
 - Discs that are badly warped or cracked.
 - Irregularly shaped discs, such as heart shapes.
- Do not expose the terminals of the card to water, garbage or dust.
- Do not place in the following areas:
 - In direct sunlight.
 - In very dusty or humid areas.
 - Near a heater.
 - Locations susceptible to significant difference in temperature (condensation can occur).
 - Where static electricity or electromagnetic waves occur.
- Put discs and cards back in their cases for protection when not using them.



Power supply

Charging the battery

When this unit is purchased, the battery is not charged. Charge the battery before using this unit.

- If the DC cable is connected to the AC adaptor, then the battery will not charge. Remove the DC cable from the AC adaptor.

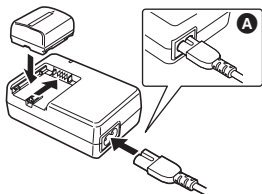

- 1 Connect the AC cable to the AC adaptor and the AC outlet.

- 2 Put the battery on the battery mount by aligning the mark, and then securely plug it in.

- The output plug of the AC cable is not completely connected to the AC adaptor jack. As shown in **A**, there is a gap.

■ Charging lamp

Lights up: Charging

Goes off: Charging completed

Flashing: The battery is over discharged (discharged excessively). In a while, the lamp will light up and normal charging will start.

When the battery temperature is excessively high or low, the CHARGE lamp flashes and the charging time will be longer than normal.

- Battery charging time (→ 26)
- We recommend using Panasonic batteries. (→ 15, 113)
- If you use other batteries, we cannot guarantee the quality of this product.

Inserting the battery

Push the battery against the battery holder and slide it until it clicks.

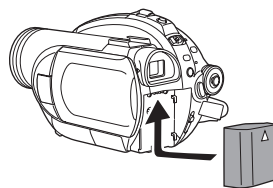

Removing the battery

While sliding the BATTERY lever, slide the battery to remove it.

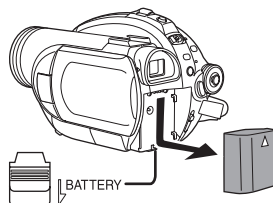

- Hold the battery with your hand so it does not fall.
- Before removing the battery, be sure to set the OFF/ON switch to OFF and check that the status indicator is off.

CAUTION

Danger of explosion if battery is incorrectly replaced. Replace only with the same or equivalent type recommended by the manufacturer. Dispose of used batteries according to the manufacturer's instructions.

Charging time and recordable time

The times shown in the tables below are for when the temperature is 25 °C (77 °F) and the humidity is 60%. If the temperature is higher or lower than 25 °C (77 °F), the charging time will become longer.

■ **Charging time**

- The charging time shown in the table are approximations.
- "1 h 40 min" indicates 1 hour 40 minutes.

Battery model number	Voltage/capacity	Charging time
Supplied battery/ CGR-DU06 (optional)	7.2 V/640 mAh	1 h 40 min
CGA-DU12 (optional)	7.2 V/1150 mAh	2 h 25 min
CGA-DU21 (optional)	7.2 V/2040 mAh	3 h 55 min

■ **Recordable time** (When using a DVD-RAM disc)

- The times indicate the recordable time when the viewfinder is used. The times in parentheses indicate the recordable time when the LCD monitor is used.
- The actual recordable time refers to the recordable time on a disc when repeatedly starting/stopping recording, turning the unit on/off, moving the zoom lever, etc.
- “1 h 5 min” indicates 1 hour 5 minutes.

Battery model number	Voltage/capacity	Recording mode	Maximum continuously recordable time	Actual recordable time
Supplied battery/ CGR-DU06 (optional)	7.2 V/ 640 mAh	XP	1 h 5 min (1 h)	30 min (25 min)
		SP	1 h 20 min (1 h 10 min)	35 min (30 min)
		LP	1 h 25 min (1 h 15 min)	35 min (30 min)
CGA-DU12 (optional)	7.2 V/ 1150 mAh	XP	2 h (1 h 50 min)	55 min (50 min)
		SP	2 h 20 min (2 h 10 min)	1 h (55 min)
		LP	2 h 30 min (2 h 15 min)	1 h 5 min (1 h)
CGA-DU21 (optional)	7.2 V/ 2040 mAh	XP	3 h 50 min (3 h 30 min)	1 h 40 min (1 h 35 min)
		SP	4 h 30 min (4 h 5 min)	2 h (1 h 50 min)
		LP	4 h 45 min (4 h 20 min)	2 h 5 min (1 h 55 min)

- The display changes as the battery capacity reduces.



If the battery discharges, then () will flash.

- The recordable times will vary depending on the status of use. These times are approximations. The recordable time will become shorter when you use both the viewfinder and the LCD monitor simultaneously while rotating the LCD monitor frontward to record yourself, etc.
- The batteries heat up after use or charging. This unit will also heat up while being used. This is not a malfunction.
- Be aware that the operating time of the battery will become shorter in low temperatures. We recommend charging a spare battery for use when recording.

Connecting to the AC outlet

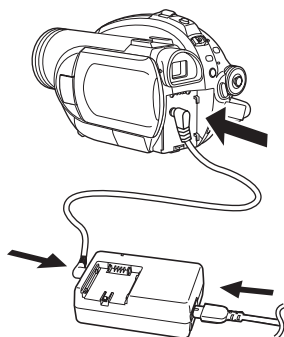

- 1** Connect the AC cable to the AC adaptor and the AC outlet.
- 2** Connect the DC cable to the AC adaptor.
- 3** Connect the DC cable to this unit.

- Do not use the AC cable with any other equipment as it is designed only for this unit. Do not use the AC cable from other equipment with this unit.
- While the DC cable is connected to the AC adaptor, the battery will not charge.

Turning the unit on/off

- When recording, remove the lens cap before turning the unit on. If the unit is turned on with the lens cap attached, the automatic white balance adjustment (→ 108) may not function properly.

How to turn on the power

While pressing the button **A**, set the OFF/ON switch to ON.

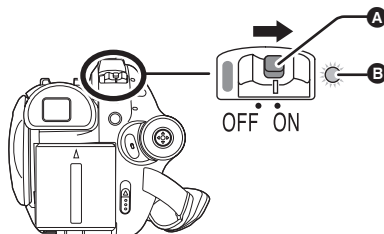

The status indicator **B** lights and the power turns on.

- When the unit is turned on for the first time, a message asking you to set the date and time will appear. Select [YES] and set the date and time. (→ 38)

How to turn off the power

While pressing the button **A**, set the OFF/ON switch to OFF.

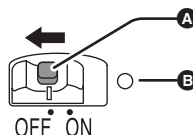

The status indicator **B** goes off when the power turns off.

When the power is turned on for the first time after changing the disc or battery, the unit carries out a recognition procedure to check that there are no problems with the disc. This takes approximately 25 seconds with DVD-RAM.

If you want to start using the unit as soon as you turn on the power, do the following.

- 1) Turn on the power.
- 2) After "READING DISC..." disappears from the screen, turn off the power.

You can start recording approximately 8 seconds after you turn on the power again.

- Depending on the condition of the disc, it may take longer than this.
- If the date and time are not set, it will take longer than usual before you can start recording.

How to turn the power on and off with the LCD monitor/viewfinder

When the OFF/ON switch is set to ON, the power can be turned on and off with the LCD monitor and the viewfinder when the unit is in video recording mode or picture recording mode.

■ To turn on the power Open the LCD monitor or extend the viewfinder.

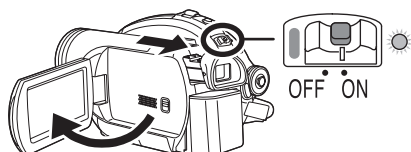

The status indicator lights and the power turns on.

■ To turn off the power

Close the LCD monitor and retract the viewfinder.

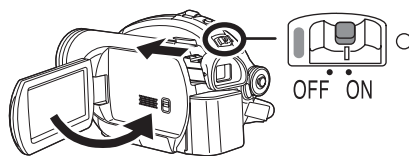

The status indicator goes off and the power turns off.

- The power will not turn off unless the LCD monitor is closed and the viewfinder is retracted.
- The power will not turn off while recording on a disc even if the LCD monitor is closed and the viewfinder is retracted.

Set the OFF/ON switch to OFF when the unit is not being used.

Inserting/removing a disc

When inserting or removing the disc, fit the charged battery pack or connect the AC adaptor to the unit. The cover of the disc compartment will not open unless the unit is powered.

1 Fit the battery or connect the AC adaptor.

2 Slide the DISC EJECT lever once and release it.

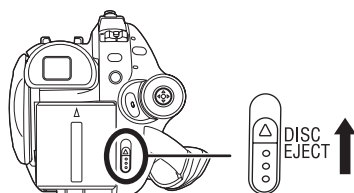

A few moments after the ACCESS/PC lamp blinks, the cover of the disc compartment will open slightly.

3 Open the cover of the disc compartment by hand and insert/remove the disc.

■ Inserting disc

Fit the disc onto the spindle in the center and then push the disc down until it clicks into place.

- Ⓐ Recording/playback side
- Ⓑ Pickup lens

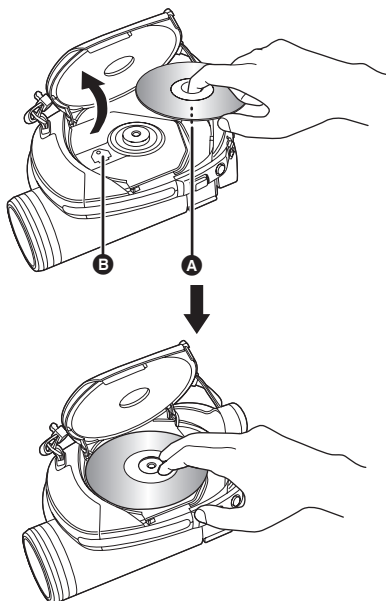

■ Removing disc

While pressing down on the spindle, grasp the edge of the disc and gently lift it out.

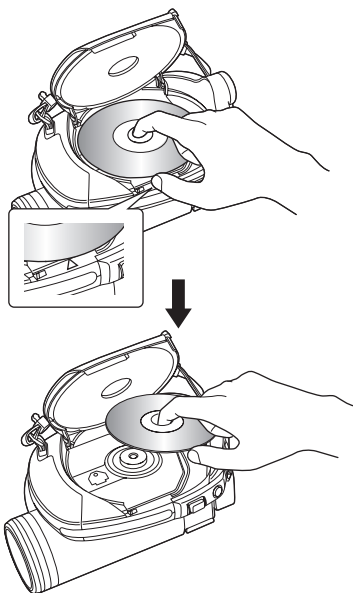

- Take care not to touch the recording/playback sides of a disc when inserting or removing it.

4 Push the section marked **PUSH CLOSE** on the cover of the disc compartment to close the cover.

- If you use a new DVD-RW, it is necessary to format the disc. (→ 22)

■ Identifying recording/playback sides of disc

Single sided disc:

The recording/playback side is opposite to the labelled side.

Double sided disc:

The "SIDE A" recording/playback side is the side opposite the side with the "SIDE A" mark. The

“SIDE B” recording/playback side is the side with the “SIDE A” mark.

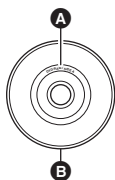

- A** “SIDE A” mark
- B** The opposite side is the “SIDE A” recording/playback side.

- Do not use excessive force when opening the cover.
- Do not touch the pickup lens or the recording/playback side of the disc.
This may impair recording and playback.
- Insert the disc securely to prevent damage.
- When you open the cover, the ACCESS/PC lamp flashes red. Do not leave the cover open.
- If the cover is open, the power will not turn off even if the OFF/ON switch is set to OFF.
- If the disc is not correctly inserted, the cover will not close. Never try to forcibly close the cover. This could cause damage. Reinsert the disc properly.
- If a single sided disc is inserted into the unit with the printed label facing the inside, an error message will appear. Remove the disc and reinsert it with its recording/playback side facing the inside.
- Do not allow the recording/playback side to become dirty or scratched.
- Do not remove the battery pack or disconnect the AC adaptor while removing the disc or until power is completely turned off. If you do, the cover will not open. If this happens, reattach the battery pack or reconnect the AC adaptor, slide the DISC EJECT lever once, and then release it. A repair disc message may be displayed when the power is turned back on. (→ 97, About recovery)
- Do not insert anything other than the 8 cm (3”) DVD-RAM, DVD-RW, DVD-R or DVD-R DL disc into the disc compartment. Doing so could cause malfunctions. (→ 21, Examples of discs that cannot be used on this unit)
- Do not touch the pickup lens or other parts inside the disc compartment. Be sure not to

touch the area around the pickup lens for it becomes extremely hot.

After inserting a disc/After recording finishes

While the ACCESS/PC lamp is lit, the disc is rotating and disc information is being recorded. If the power supply is interrupted at this time, the disc may become unusable. Do not disconnect the AC adaptor or remove the battery. Also, do not strongly shake or cause impact to the unit.

Inserting/removing an SD card

Before inserting/removing an SD card, be sure to set the OFF/ON switch to OFF.

If the SD card is inserted or removed while the OFF/ON switch is set to ON, this unit may malfunction or the data recorded on the SD card may be lost.

1 Set the OFF/ON switch to OFF to turn off the power.

- Check that the status indicator has gone off.

2 Slide the card slot cover to open.

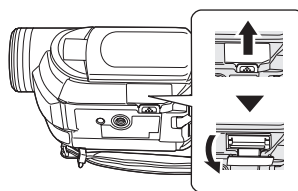

3 Insert/remove the SD card into/from the card slot.

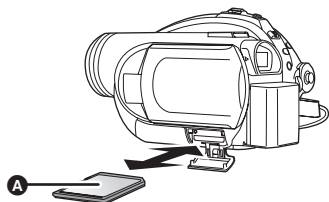

- When inserting an SD card, face the label side **A** upwards and press it straight in as far as it goes.
- When removing the SD card, press the center of the SD card and then pull it straight out.

4 Securely close the card slot cover.

■ Concerning the SD card

- Electrical noise, static electricity or failure of this unit or the SD card may damage or erase the data stored on the SD card. We recommend saving important data on a computer.

■ Card access lamp

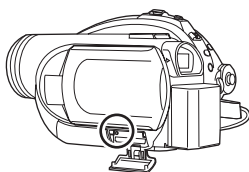

- When this unit accesses the SD card (reading, recording, playback, erasing, etc.), the access lamp lights up.
- If the following operations are performed when the access lamp is lit, then the SD card or the recorded data may be damaged or this unit may malfunction.
 - Removing the SD card
 - Operating the OFF/ON switch or the mode dial
 - Removing the battery or disconnecting the AC adaptor

Selecting a mode

The mode dial is used to switch between recording and playback modes. Rotate the mode dial slowly but surely.

Rotate the mode dial, and set the desired mode pictograph to the position shown in the illustration.

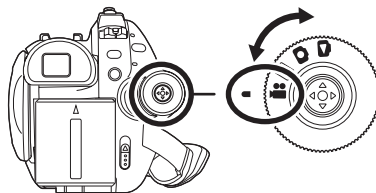

Video recording mode (→ 42)

Use this to record motion pictures on a disc.



Video playback mode (→ 59)

Use this to play back motion pictures on a disc.



Picture recording mode (→ 45)

Use this to record still pictures on an SD card.



Picture playback mode (→ 62)

Use this to play back still pictures on an SD card.

- Do not forcefully rotate the dial.

How to use the joystick

This unit has a joystick for selecting functions, performing operations, etc. so it is easy to operate this unit with one hand.

Basic operations

Operations on the menu screen and selection of files on the thumbnail view screen, etc.

Move the joystick up, down, left, or right to select an item or scene, and then press the joystick to set it.

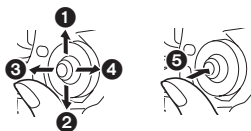

- 1 Select by moving up.
 - 2 Select by moving down.
 - 3 Select by moving left.
 - 4 Select by moving right.
 - 5 Press the joystick to select the item.
- Menu screen operations (→ 36)

Operations during recording

◇ Rotate the mode dial to select  or .

1 Press the center of the joystick, and icons will be displayed on the screen.



- The indication disappears when the center of the joystick is pressed again.
- The indication changes each time the joystick is moved down.

2 Move the joystick up, left or right to select an item.

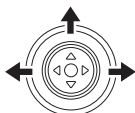

Operations during playback

◇ Rotate the mode dial to select  or .

1 Move the joystick up, down, left or right to select the scene to be played back and press the joystick.

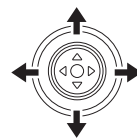
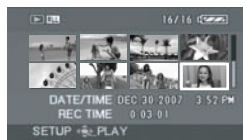

The selected scene is played back on the full screen.

The operation icon is automatically displayed on the screen.

2 Move the joystick up, down, left or right to operate.

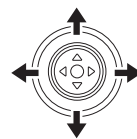

- The operation icon appears or disappears each time the center of the joystick is pressed.

About the operation icons displayed in each mode

About auto mode and manual mode (→ 41)

Video recording mode

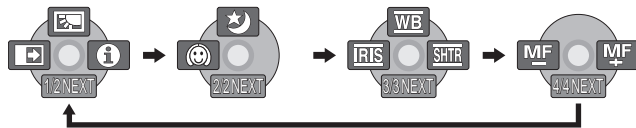

Icon	Direction	Function	Page	
(1/2)		▲	Backlight compensation	50
		◀	Fade	50
		▶	Help mode	36
(2/2)		▲	MagicPix	51
		◀	Soft skin mode	51
In manual mode (3/3)		▲	White balance	56
		◀	Iris or gain value	57
		▶	Shutter speed	57
In manual focus mode (4/4)		◀▶	Manual focus adjustment	55

- The shaded operation icons are not displayed while recording.

Video playback mode



Icon	Direction	Function	Page
	▲	Playback/pause	59
	▼	Stop playback and show thumbnails	59
	◀	Skip	59
		Rewind	60
		Reverse slow/frame playback (during pause)	60
	▶	Skip	59
		Fast forward	60
		Forward slow/frame playback (during pause)	60

Picture recording mode

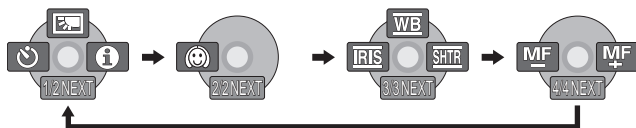

Icon	Direction	Function	Page	
(1/2)		▲	Backlight compensation	50
		◀	Self timer	52
		▶	Help mode	36
(2/2)		◀	Soft skin mode	51
In manual mode (3/3)		▲	White balance	56
		◀	Iris or gain value	57
		▶	Shutter speed	57
In manual focus mode (4/4)		◀▶	Manual focus adjustment	55



Picture playback mode



Icon	Direction	Function	Page
	▲	Slide show start/pause	62
	▼	Stop playback and show thumbnails	62
	◀	Playback previous picture (during pause)	62
	▶	Playback next picture (during pause)	62

■ Help mode

The help mode explains the operation icons that are displayed when the AUTO/MANUAL/FOCUS switch is set to AUTO in video/picture recording mode.

◇ Rotate the mode dial to select  or .

1 Press the joystick to display the icon during the recording pause.



2 Move the joystick right to select .



3 Move the joystick up, left or right to select the desired icon.



- An explanation of the selected icon is displayed on the screen.
- The indication changes each time the joystick is moved down.

To exit the help mode

Press the MENU button or select [EXIT].



- When the help mode is used, functions cannot be set.
- When the help mode is used, motion pictures and still pictures cannot be recorded.

Switching the language

You can switch the language on the screen display or the menu screen.

1 Press the MENU button, then select [LANGUAGE] and press the joystick.

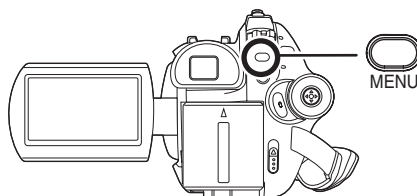

2 Select [English] and press the joystick.

Using the menu screen

Refer to "Menu list" (→ 91) for information about the menus.

1 While stopped, press the MENU button.

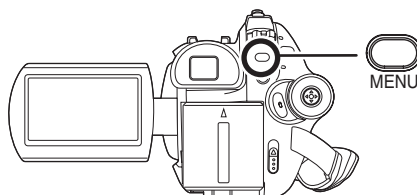

The menu displayed differs depending on the position of the mode dial.

- Do not switch the mode dial when the menu is displayed.

- 2** Move the joystick up or down in order to select the desired top menu.



- 3** Move the joystick right or press the joystick.



- 4** Move the joystick up or down in order to select the submenu item.

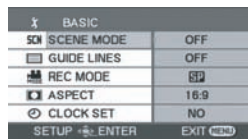

- 5** Move the joystick right or press the joystick.



- 6** Move the joystick up or down in order to select the desired item.

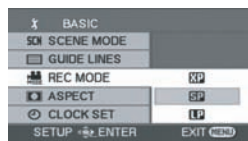

- 7** Press the joystick to enter the selection.



To get back to the previous screen

Move the joystick left.

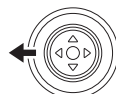

To exit the menu screen

Press the MENU button.





- The menu screen does not appear during recording or playing. You cannot start other operations while the menu screen appears.

Setting date and time

When the unit is turned on for the first time, a message asking you to set the date and time will appear.

- Select [YES] and press the joystick. Perform steps 2 and 3 below to set the date and time.

If the screen shows the incorrect date and time, then adjust it.

- ◇ Rotate the mode dial to select  or .

- 1 Press the MENU button, then select [BASIC] → [CLOCK SET] → [YES] and press the joystick.

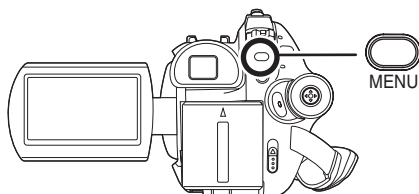

- 2 Move the joystick left or right to select the item to be set. Then, move the joystick up or down to set the desired value.

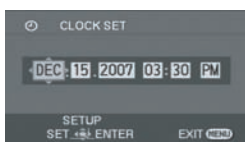

- The year will change as follows: 2000, 2001, ..., 2099, 2000, ...
- The 12-hour system is used to display the time.

- 3 Press the joystick to enter the selection.

- The clock function starts at [00] seconds when the joystick is pressed.
- After pressing the MENU button to finish the setting, check the date and time display.

- Changing the date and time display style
Press the MENU button, then select [SETUP] → [DATE/TIME] → desired display style and press the joystick.

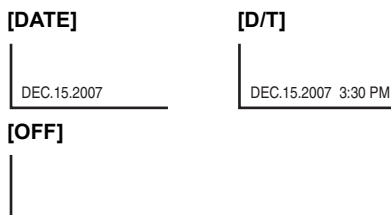

- Changing the display style
Press the MENU button, then select [SETUP] → [DATE FORMAT] → desired display style and press the joystick.

Display style	Screen display
[Y/M/D]	2007.DEC.15
[M/D/Y]	DEC.15.2007
[D/M/Y]	15.DEC.2007

- The date and time function are driven by a built-in lithium battery.
- Make sure to check the time before recording.
- If the time display becomes [- -], the built-in lithium battery has run down. Use the following steps to charge the battery. When you turn on the power for the first time after charging, a message asking you to set the date and time will appear. Select [YES] and set the date and time.

To recharge the built-in lithium battery

Connect the AC adaptor or attach the battery to the unit, and the built-in lithium battery will be recharged. Leave the unit as it is for approx. 24 hours and the battery will save the date and time for approx. 6 months. (Even if the OFF/ON switch is set to OFF, the battery is still being recharged.)

Adjusting LCD monitor/ viewfinder

Adjusting the brightness and color level

- 1 Press the MENU button, then select [SETUP] → [LCD SET] or [EVF SET] → [YES] and press the joystick.

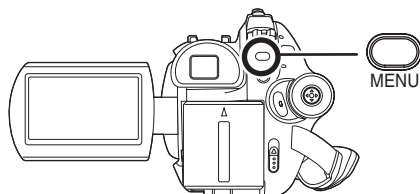

- 2 Move the joystick up or down to select the item to be adjusted. Then, move the joystick left or right to make the adjustment.



The bar display moves.

■ [LCD SET]

[BRIGHTNESS]:

Brightness of the LCD monitor

[COLOR]:

Color level of the LCD monitor

■ [EVF SET]

[BRIGHTNESS]:

Brightness of the viewfinder

- To adjust the brightness of the viewfinder, extend the viewfinder and close the LCD monitor to activate the viewfinder.
- When the LCD monitor is rotated by 180° towards the lens, the brightness and color level of the LCD monitor cannot be adjusted.
- These settings will not affect the images actually recorded.

Adjusting the field of view

Adjust the focus by sliding the eyepiece corrector knob.

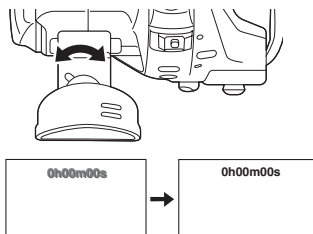

Before recording

Basic camera positioning

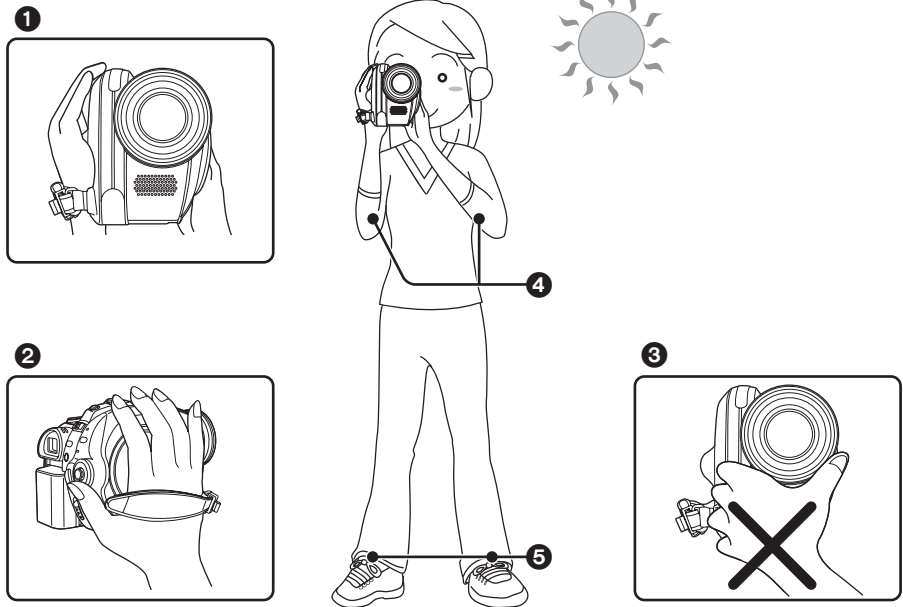

- ❶ Hold the camera with both hands.
 - ❷ Put your hand through the grip belt.
 - ❸ Do not cover the microphones or sensors with your hands.
 - ❹ Keep your arms near your body.
 - ❺ Slightly open your legs.
- When you are outdoors, record pictures with the sunlight behind you. If the subject is backlit, it will become dark in the recording.
 - When recording, make sure your footing is stable and there is no danger of colliding with another person or an object.

■ About auto mode

Set the AUTO/MANUAL/FOCUS switch to AUTO, and color balance (white balance) and focusing will be adjusted automatically.

- Auto white balance (→ 108)
- Auto focusing (→ 109)

Depending on the brightness of the subject etc., the aperture and shutter speed are automatically adjusted for an optimum brightness.

(When set to the video recording mode: The shutter speed is adjusted to a maximum of 1/250.)

- Color balance and focus may not be adjusted automatically depending on light sources or scenes. If so, manually adjust these settings.
 - Scene mode (→ 54)
 - White balance (→ 56)
 - Shutter speed (→ 57)
 - Iris/gain value (→ 57)
 - Focus (→ 55)

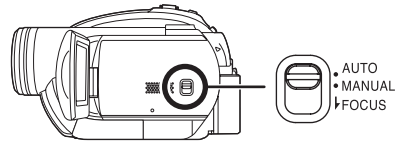

Recording motion pictures

RAM -RW(VR) -RW(V) -R

Record motion pictures onto a disc.

- When the unit is purchased, the aspect ratio is set to [16:9] for recording images compatible with a wide-screen TV.
To watch images on a regular TV (4:3), change the aspect ratio setting (→ 53) before recording the images or when watching them on the connected TV (→ 78).
- Remove the lens cap before turning the unit on.
If the unit is turned on with the lens cap attached, the automatic white balance adjustment may not function properly.

1 Turn the unit on.

2 Rotate the mode dial to select .

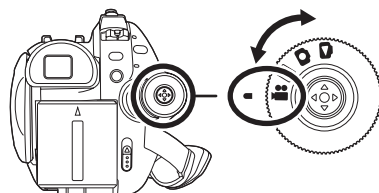

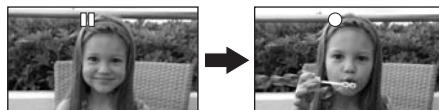
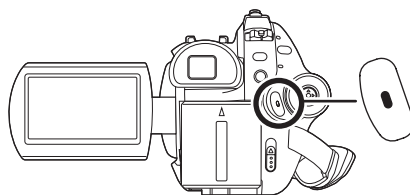

3 Open the LCD monitor or extend the viewfinder.

4 Press the recording start/stop button to start recording.



To end the recording

Press the recording start/stop button again to pause recording.

-  and  are red during recording. Do not move this unit until  is green.



- The images recorded between pressing the recording start/stop button to start recording and pressing it again to pause recording become one scene.

- When about 5 minutes have passed without any operation in recording pause, the unit automatically turns off to prevent the battery from running down. When you want to use the unit, turn it on again. This setting can also be set to [OFF]. (→ 92, [POWER SAVE])

Screen indications in the video recording mode

- A** Recording mode
- B** Remaining time left for recording
(When the remaining time is less than 1 minute, [R 0min] flashes red.)
- C** Recording time elapsed



- The maximum number of scenes on a disc (per side): 999 (Even if there is remaining capacity for recording on a disc, you may not be able to record 999 scenes.)
- Maximum number of dates on a disc (per side): 99 (Even if scenes are recorded on the same day, they may be grouped on a different recording date.) (→ 61)
- Sound is recorded in Dolby Digital from the internal stereo microphone on the front of the unit. Take care not to block this microphone.
- Each time the unit enters the recording pause mode, the counter display will be reset to "0h00m00s".
- While motion picture recording is in progress, the recording will not stop even if the LCD monitor is closed and the viewfinder is retracted.
- While "WRITING CONTROL DATA TO THE DISC. DO NOT SHAKE THE UNIT." is displayed, do not disconnect the AC adaptor or remove the battery as doing so may make the disc unusable.
- While motion picture recording is in progress, do not disconnect the AC adaptor or remove the battery. If you do, a repair disc message may be displayed when the power is turned back on. (→ 97, About recovery)

The ACCESS/PC lamp lights immediately after recording finishes. While it lights, the disc is rotating and disc information is being recorded. If you run while holding the unit or swing it, the recorded images may be distorted so do not strongly shake or cause impact to it.

Recording modes and recordable time available for the motion picture

Changing the recording mode of the motion picture.

Press the MENU button, then select [BASIC] → [REC MODE] → desired item and press the joystick.

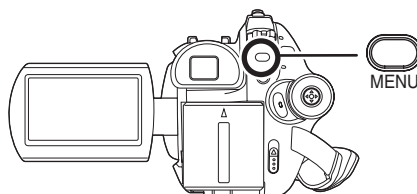

Recording

■ Approximate recordable time for 1 disc (single sided)

Disc type	Recording mode		
	XP (High quality)	SP (Normal)	LP (Long play)
DVD-RAM	Approx. 18 min	Approx. 37 min	Approx. 75 min
DVD-R DL	Approx. 35 min	Approx. 69 min	Approx. 138 min

Image quality
prioritized



Recording time
prioritized

- This unit records in VBR. VBR is an abbreviation for Variable Bit Rate. VBR recording automatically varies the bit rate (amount of data in a fixed time) depending on the subject being recorded. This means if a subject with sharp movements is recorded, the recording time is reduced.
 - Mosaic-pattern noise may appear on a playback image in the following cases.
 - When there is a complicated pattern in the background
 - When the unit is moved too much or too fast
 - When a subject with sharp movements has been recorded (Particularly if it has been recorded in [LP] mode.)
-

Recording still pictures (JPEG still pictures)

SD

Record the still picture on an SD card.

- When this unit is purchased, [PICTURE SIZE] is set to [0.2M] for recording pictures compatible with a wide-screen TV (16:9).
To record pictures with a 4:3 aspect ratio, change the [PICTURE SIZE] setting before recording (→ 46).
- Remove the lens cap before turning the unit on.
If the unit is turned on with the lens cap attached, the automatic white balance adjustment may not function properly.

1 Turn the unit on.

2 Rotate the mode dial to select .

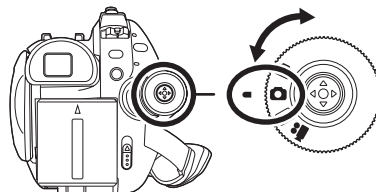

3 Open the LCD monitor or extend the viewfinder.

4 Press the Photoshot button .

The unit automatically focuses on the subject at the center of screen (when auto focus is selected).

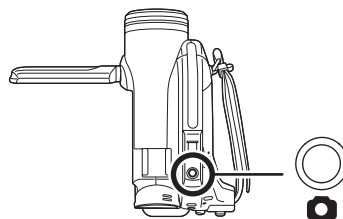

- For information about the number of recordable still pictures on an SD card (→ 112)
- The sound cannot be recorded.
- If the write protection switch on the SD card is set to LOCK, it cannot be used for recording.
- If the [PICT.QUALITY] is set to [L], mosaic-pattern noise may appear on a playback image depending on the picture content.
- While this unit accesses the SD card (→ is displayed/the access lamp is lit), do not perform the following operations. The SD card or the recorded data may be damaged.
 - Turn the unit off.
 - Remove the SD card.
 - Operate the mode dial.
- Other products may degrade or not play back still pictures recorded on this unit.

Recording

■ To record still pictures clearly

- When zooming in on the subject with a magnification of 4× or higher, it is difficult to reduce the slight shaking from holding this unit by hand. We recommend decreasing the zoom magnification and approaching the subject when recording.
- When recording still pictures, hold the unit firmly with your hands and keep your arms stationary at your side so as not to shake the unit.
- You can record stable pictures without shaking by using a tripod.

Screen indications in picture recording mode

- A** Remaining number of still pictures
(Flashes in red when [R 0] appears.)
- B** Size of still pictures
- C** Quality of still pictures



Recording with a shutter operation effect

You can add a shutter sound when recording still pictures.

Press the MENU button, then select [ADVANCED] → [SHTR EFFECT] → [ON] and press the joystick.

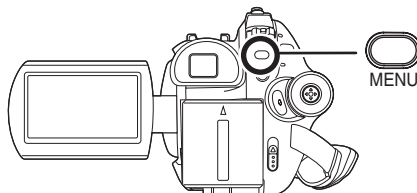

- This function's default setting is [ON].

Number of pixels and picture quality for still picture recording

■ [PICTURE SIZE]

Changing the recording size.

Press the MENU button, then select [BASIC] → [PICTURE SIZE] → desired item and press the joystick.

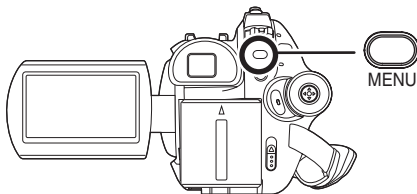

Icon	Aspect	Number of pixels
	4:3	640×480
	16:9	640×360

-
- When this unit is purchased, [PICTURE SIZE] is set to [0.2m]. The sides of pictures recorded with a 16:9 aspect ratio may be cut at printing. Check before printing.

■ [PICT.QUALITY]

Selecting the picture quality.

Press the MENU button, then select [BASIC] → [PICT.QUALITY] → desired item and press the joystick.

 : Still pictures with a high picture quality are recorded.



 : Priority is given to the number of still pictures recorded. Still pictures are recorded in normal picture quality.

Various recording functions

Zoom in/out function

RAM -RW(VR) -RW(V) -R SD

You can zoom in up to 32× optically.

◇ Rotate the mode dial to select  or .

Move the zoom lever.

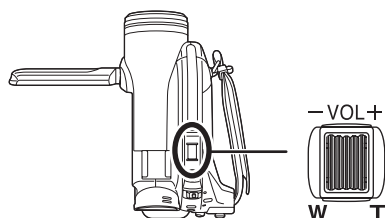

T side: Close-up recording (zoom in)

W side: Wide-angle recording (zoom out)

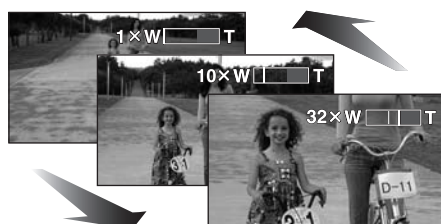

- When zooming in while holding this unit by hand, we recommend using the image stabilizer function. (→ 53)
- When distant subjects are brought closer, they are focused at about 1.3 m (4.3 feet) or more.
- When the zoom magnification is 1×, this unit can focus on a subject approx. 2 cm (0.8") away from the lens. (Macro function)
- The zoom speed varies depending on the range over which the zoom lever is moved.
- When the zoom speed is high, the subject may not be focused easily.
- If you take your finger off the zoom lever during zoom operation, the operation sound may be

recorded. When returning the zoom lever to the original position, move it quietly.

Digital zoom function

RAM -RW(VR) -RW(V) -R

If the zoom magnification exceeds 32×, then the digital zoom function will be activated. The maximum magnification provided by the digital zoom can be switched.

◇ Rotate the mode dial to select .

Press the MENU button, then select [ADVANCED] → [D.ZOOM] → desired item and press the joystick.

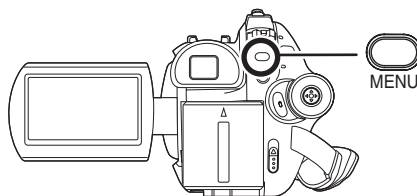

[OFF]: Optical zoom only (Up to 32×)

[50×]: Up to 50×

[1000×]: Up to 1000×

• If [50×] or [1000×] is selected, the digital zoom range is displayed in blue while zooming.

- The larger the digital zoom magnification, the more the image quality is degraded.
- This function cannot be used in picture recording mode.

To use the zoom microphone function

RAM -RW(VR) -RW(V) -R

The zoom microphone is linked to the zooming operation so that far-away sounds with a tele-shot and close-up sounds with a wide-angle shot are recorded more clearly.

◇ Rotate the mode dial to select .

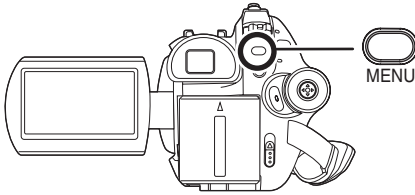

Press the MENU button, then select [ADVANCED] → [ZOOM MIC] → [ON] and press the joystick.



Recording yourself

RAM -RW(VR) -RW(V) -R SD

You can record yourself while viewing the LCD monitor. You can record persons in front of the unit while showing them the image.

◇ Rotate the mode dial to select  or .

Rotate the LCD monitor towards the lens side.

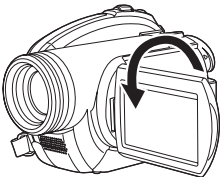

The image is horizontally flipped as if you see a mirror image. (However the image recorded is the same as a normal recording.)



- Extend the viewfinder to see the picture while recording.
 - When the recording aspect is 16:9, the image displayed on the viewfinder screen is squeezed horizontally, but this is normal and not a sign of any malfunction.
-
- When the LCD monitor is rotated towards the lens side, the icon will not be displayed even if you press the joystick.
 - Only some indications will appear on the screen. When  appears, return the direction of the LCD monitor to normal position and check the warning/alarm indication. (→ 96)

Recording with the video light

This built-in video light is for recording in dark places.

RAM -RW(VR) -RW(V) -R SD

Gain up mode works with the video light to enhance the light's brightness and brighten the natural colors in a scene.

◇ Rotate the mode dial to select  or .

Press the LIGHT button.

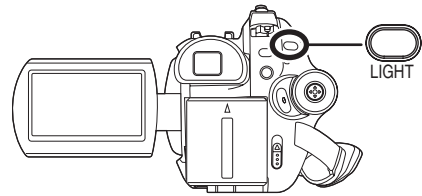

Each time you press the LIGHT button:

- 1 **Video light and gain up mode on:**
Brighter than when only the video light is on, but washed out images will appear.
- 2 **Video light on:**
To eliminate washed out images, use this mode.
- 3 **Video light off**

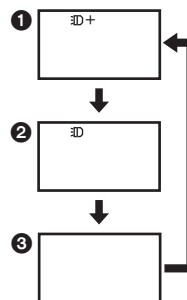

- The subject should be within 1.5 m (5 feet) of the unit.
- Using the video light reduces battery time.
- Set the video light to off when not in use.
- Do not look directly into the light.

Recording



- If the video light is used with a conversion lens attached, a slight vignetting (darkening around edges) effect occurs on the screen.
- Using the MagicPix function at the same time will make conditions even brighter.
- The video light enables brightening of the images taken in a dimly-lit place. We also recommend using it in a bright place to obtain high quality images.
- If you turn off the power or operate the mode dial, the video light is turned off.

Backlight compensation function

This is for protecting a backlit subject from being darkened.

RAM -RW(VR) -RW(V) -R SD

Use this function when the light is emanating from behind the subject and the subject appears dark.

- ◇ Rotate the mode dial to select  or .

- 1** Press the joystick. Then move the joystick down to display the icon shown in the illustration.



- 2** Move the joystick up to select .



The image on the screen will become brighter.

To return to normal recording

Select  again.

- If you turn off the power or operate the mode dial, the backlight compensation function is canceled.

Fade in/fade out function

RAM -RW(VR) -RW(V) -R

Fade in: The image and audio gradually appear.

Fade out: The image and audio gradually disappear.

- ◇ Rotate the mode dial to select .

- 1** Press the joystick. Then move the joystick down to display the icon shown in the illustration.



- 2** Move the joystick left to select .



- 3** Press the recording start/stop button.

Start recording. (Fade in)



When you start recording, the image/audio gradually appears.

Pause recording. (Fade out)



The image/audio gradually disappears. After the image/audio completely disappears, recording stops.

- After recording, the fade setting is canceled.

To cancel fading

Select [**REVERSE**] again.

To select the color for fade in/out

The color which appears in fading pictures can be selected.

Press the MENU button, then select [ADVANCED] → [FADE COLOR] → [WHITE] or [BLACK] and press the joystick.



- If you turn off the power, the fade function is canceled.
- While the fade in/fade out function is selected, it takes several seconds to display the image when you start recording. It also takes several seconds to pause recording.
- The thumbnails of scenes recorded using fade in become black (or white).

Soft skin mode

This makes skin colors appear softer for a more attractive appearance.

RAM -RW(VR) -RW(V) -R SD

This is more effective if you record a person closely from the torso up.

◇ Rotate the mode dial to select  or .

1 Press the joystick. Then move the joystick down to display the icon shown in the illustration.



2 Move the joystick left to select [].



To cancel the soft skin mode

Select [] again.

- If the background or anything else in the scene has colors similar to the skin color, they will also be smoothed.
- If the brightness is insufficient, the effect may not be clear.
- You may not be able to see the face clearly when recording a distant person. In this case, cancel soft skin mode or zoom in on the face.

MagicPix function

This allows recording in dark locations.

RAM -RW(VR) -RW(V) -R

This function allows you to record color subjects in dark locations to stand out against the background.

Attach this unit to a tripod, and you can record images free from vibration.

- Minimum required illumination: approx. 2 lx
- Recorded scene is seen as if frames were missed.

◇ Rotate the mode dial to select .

- 1 Press the joystick. Then move the joystick down to display the icon shown in the illustration.



- 2 Move the joystick up to select [★].



- If it is difficult to focus, adjust the focus manually. (→ 55)

To cancel the MagicPix function

Select [★] again.

- The MagicPix function makes the signal charging time of CCD up to approximately 30× longer than usual, so that dark scenes can be recorded brightly. For this reason, bright dots that are usually invisible may be seen, but this is not a malfunction.
- If you turn off the power or operate the mode dial, the MagicPix function is canceled.
- If set in a bright place, the screen may become whitish for a while.

Self-timer recording

This is for recording shots of yourself as well.

SD

You can record still pictures on an SD card using the timer.

- ◇ Rotate the mode dial to select .

- 1 Press the joystick. Then move the joystick down to display the icon shown in the illustration.



- 2 Move the joystick left to select [⌚].



- 3 Press the Photoshot button [📷].

After the [⌚] display flashes for approx. 10 seconds, a still picture will be recorded.

- After recording, the self-timer is canceled.

To stop the timer midway through

Press the MENU button. (The self-timer setting is canceled.)

- If you turn off the power, the self-timer standby mode is canceled.
- Depending on the time taken to bring the subject into focus, the recording may take longer than set to start.

Recording guideline function

Checking if the image is level.

RAM -RW(VR) -RW(V) -R SD

You can check if the image is level while recording by using the lines displayed on the screen.

- ◇ Rotate the mode dial to select or .

Press the MENU button, then select [BASIC] → [GUIDE LINES] → [ON] and press the joystick.

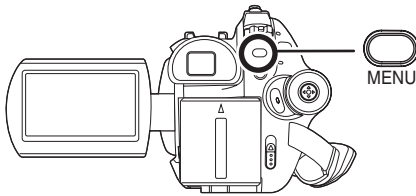

To cancel the Recording guideline function

Press the MENU button, then select [BASIC] → [GUIDE LINES] → [OFF] and press the joystick.

- The guidelines do not appear on the images actually recorded.
- The guidelines are not displayed while rotating the LCD monitor forward to record yourself.

Wide mode

This is for selecting the screen's aspect ratio when recording motion pictures.

RAM -RW(VR) -RW(V) -R SD

This allows you to record images compatible with wide-screen TVs (16:9) and regular TVs (4:3).

Recording images with a 16:9 aspect ratio

◇ Rotate the mode dial to select . Press the MENU button, then select [BASIC] → [ASPECT] → [16:9] and press the joystick.

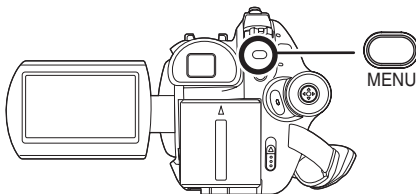

Recording images with a 4:3 aspect ratio

◇ Rotate the mode dial to select . Press the MENU button, then select [BASIC] → [ASPECT] → [4:3] and press the joystick.

- The default setting is [16:9].

Image stabilizer function

This is for reducing image shakes (jitter) during recording.

RAM -RW(VR) -RW(V) -R SD

Reduces the image shaking (jitter) due to hand movement when recording.

◇ Rotate the mode dial to select or .

Press the MENU button, then select [ADVANCED] → [O.I.S.] → [ON] and press the joystick.

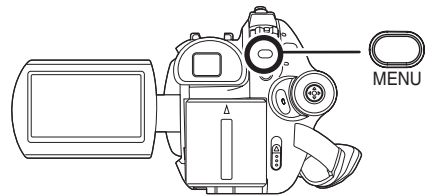

To cancel the image stabilizer function

Press the MENU button, then select [ADVANCED] → [O.I.S.] → [OFF] and press the joystick.

- This function's default setting is [ON].
- In the following cases, the image stabilizer function may not work effectively.
 - When the digital zoom is used
 - When the unit is shaken greatly
 - When you record a moving subject while tracking it

Wind noise reduction function

This is for reducing the wind noise coming into the microphone when recording.

RAM -RW(VR) -RW(V) -R

◇ Rotate the mode dial to select .

Press the MENU button, then select [ADVANCED] → [WIND CUT] → [ON] and press the joystick.

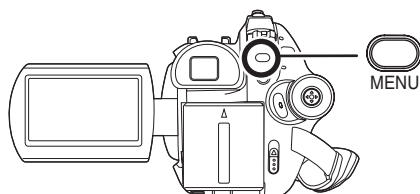

To cancel the wind noise reduction function

Press the MENU button, then select [ADVANCED] → [WIND CUT] → [OFF] and press the joystick.

- This function's default setting is [ON].
- The wind noise reduction depends on the wind strength. (If this function is activated in strong winds, the stereo effect may be reduced. When the wind weakens, the stereo effect will be restored.)



Manual recording functions

Scene mode

This is for recording in various situations.

RAM -RW(VR) -RW(V) -R SD

When you record images in different situations, this mode automatically sets optimum shutter speeds and apertures.

◇ Rotate the mode dial to select  or .

1 Set the AUTO/MANUAL/FOCUS switch to MANUAL.

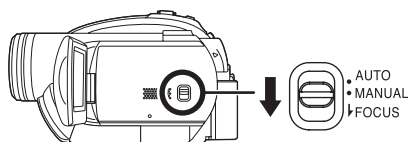

2 Press the MENU button, then select [BASIC] → [SCENE MODE] → desired item and press the joystick.

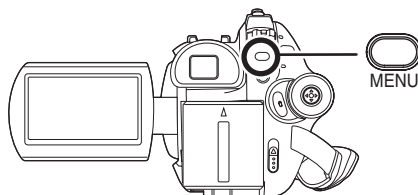

[] Sports

To record sports scenes or scenes where there are quick motions

[] Portrait

To make people stand out against the background

[] Low light

To make the scene brighter in dark conditions

[] Spotlight

To make the subject under a spotlight look more attractive

[] Surf & snow

To record images in bright places such as ski slopes and beaches

To cancel the scene mode function

Press the MENU button, then select [BASIC] → [SCENE MODE] → [OFF] and press the joystick.

- You can also cancel the scene mode function by setting the AUTO/MANUAL/FOCUS switch to AUTO.

Sports mode

- For slow-motion playback or playback pause of recorded pictures, this mode helps diminish camera shake.
- During normal playback, the image movement may not look smooth.
- Avoid recording under fluorescent light, mercury light or sodium light because the color and brightness of the playback image may change.
- If you record a subject illuminated with strong light or a highly reflective subject, vertical lines of light may appear.
- If the brightness is insufficient, the sports mode does not function. The [] display flashes.
- If this mode is used indoors, the screen may flicker.

Portrait mode

- If this mode is used indoors, the screen may flicker. If so, change the scene mode setting to [OFF].

Low light mode

- Extremely dark scenes may not be able to be recorded finely.

Spotlight mode

- If the recording subject is extremely bright, the recorded image may become whitish and the periphery of the recorded image extremely dark.



Surf & snow mode

- If the subject is extremely bright, the recorded image may become whitish.

Manual focus adjustment

RAM -RW(VR) -RW(V) -R SD

If auto focusing is difficult due to the conditions, then manual focusing is available.

- ◇ Rotate the mode dial to select  or .

1 Set the AUTO/MANUAL/FOCUS switch to MANUAL.

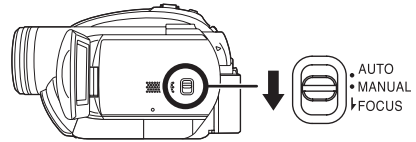

2 Move the switch down and set it to FOCUS position.



The manual focus indication [MF] and the icon shown in the illustration appear.

3 Move the joystick left or right to bring the subject into focus.



- The subject may not be in focus when zoomed in if focusing with a wide angle. First, zoom in on the subject, and then focus on it.

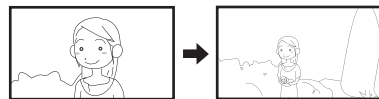

To restore to the automatic adjustment

Press the AUTO/MANUAL/FOCUS switch down again to the FOCUS position.

- You can also restore the auto focusing by setting the AUTO/MANUAL/FOCUS switch to AUTO.

White balance

This is for recording in natural colors.

RAM -RW(VR) -RW(V) -R SD

The automatic white balance function may not reproduce natural colors depending on the scenes or lighting conditions. If so, you can adjust the white balance manually.

◇ Rotate the mode dial to select or .

1 Set the AUTO/MANUAL/FOCUS switch to **MANUAL**.



The icon shown in the illustration is displayed automatically.

2 Move the joystick up to select **[WB]**.



3 Move the joystick left or right to select the white balance mode.



[AWB] Auto white balance adjustment
[WB] Indoor mode (for recording under incandescent lamps)

- Incandescent lights, halogen lamps

[WB] Outdoor mode

- Outdoors under a clear sky

[WB] Manual adjustment mode

- Mercury-vapor lamps, sodium lamps, some fluorescent lights
- Lights used for wedding receptions at hotels, stage spotlights in theaters
- Sunrise, sunset, etc.

To restore to the automatic adjustment

Set the white balance mode to **[AWB]**.

- You can also restore the automatic adjustment by setting the AUTO/MANUAL/FOCUS switch to AUTO.

To set the white balance manually

1 Select **[WB]**, and fill the screen with a white subject.

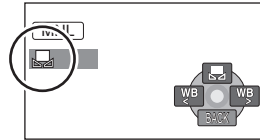

2 Move the joystick up to select **[WB]**.

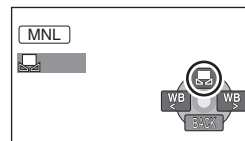

When the **[WB]** display changes from flashing to on, setting is complete.

- When the **[WB]** display continues flashing, the white balance cannot be set because the place is dark etc. In this case, use the automatic white balance.

■ About the white balance sensor **A**

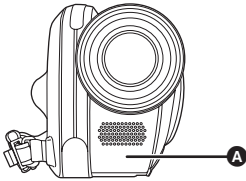

The white balance sensor detects the type of light source during recording. Do not cover the white balance sensor during recording, or it may not function properly.

- When the unit is turned on with the lens cap attached, the automatic white balance adjustment may not function properly. Please turn the unit on after removing the lens cap.
- When the [MNL] display flashes, the manual white balance previously adjusted is stored. Whenever recording conditions change, re-set the white balance for correct adjustment.
- When setting both the white balance and the iris/gain, set the white balance first.

Manual shutter speed/ aperture adjustment



RAM -RW(VR) -RW(V) -R SD

Shutter Speed:

Adjust it when recording fast-moving subjects.

Aperture:

Adjust it when the screen is too bright or too dark.

◇ Rotate the mode dial to select  or .

1 Set the AUTO/MANUAL/FOCUS switch to MANUAL.



The icon shown in the illustration is displayed automatically.

2 Move the joystick left or right to select [IRIS] (aperture) or [SHTR] (shutter speed).



3 Move the joystick left or right to make the adjustment.



A Shutter speed:

 1/60 to 1/8000

 1/60 to 1/500

- The shutter speed closer to 1/8000 is faster.

B Iris/Gain value:

CLOSE → (F16 to F2.0) → OPEN → (0dB to 18dB)

- Value closer to [CLOSE] darken the image.
- Value closer to [18dB] brighten the image.
- When the iris value is adjusted to brighter than [OPEN], it changes to the gain value.

To restore to automatic adjustment

Set the AUTO/MANUAL/FOCUS switch to AUTO.

- When setting both the shutter speed and the iris/gain value, set the shutter speed and then set the iris/gain value.

■ Manual shutter speed adjustment

- Avoid recording under fluorescent light, mercury light or sodium light because the color and brightness of the playback image may change.

Recording

- If you increase the shutter speed manually, the gain value will increase automatically depending on how much the sensitivity lowers and the noise on the screen may increase.
- You may see vertical lines of light in the playback image of a brightly shining subject or highly reflective subject, but this is not a malfunction.
- During normal playback, image movement may not look smooth.
- When recording in an extremely bright place, the screen may change color or flicker. If so adjust the shutter speed manually to [1/60] or [1/100].

■ Manual iris/gain adjustment

- If the gain value is increased, the noise on the screen increases.
- Depending on the zoom magnification, there are iris values that are not displayed.

Motion picture playback

RAM -RW(VR) -RW(V) -R

Play back the motion pictures recorded on the disc.

1 Rotate the mode dial to select .

The motion pictures recorded on the disc are displayed as thumbnails.

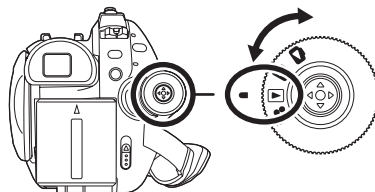

2 Select the scene to be played back.

- A** Scene number
- B** Scroll bar display

The selected scene will be encircled by a yellow frame.

- When 9 or more scenes have been recorded, the next (or previous) page is displayed by moving the joystick.
- If you move and hold the joystick up or down, you can advance 8 scenes at a time. The screen will not change at this time, but the scene numbers and scroll bar display will change so release the joystick when you have arrived at the page with the scene you want to display.

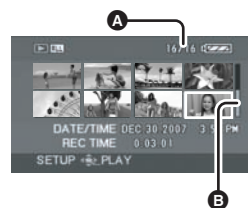



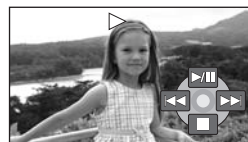

3 Press the joystick.

The selected scene is played back on the full screen.
The operation icon is automatically displayed on the screen.



4 Move the joystick to operate.

- : Playback/Pause
- : Skip playback (backward)
- : Skip playback (forward)
- : Stops the playback and shows the thumbnails.

- No sound will be heard except during normal playback.
- If pause play is continued for 5 minutes, the screen returns to the thumbnails.
- When the amount of time recorded on the scene is short, playback may not be possible.
- When a scene is displayed as [!] on the thumbnail display, playback is not possible.
- The power will not turn off when the LCD monitor and the viewfinder are closed and retracted.
- When playing back a motion picture recorded with other products on this unit or playing back a motion picture recorded with this unit on other products, the picture quality may deteriorate and it may be unplayable. (The message "CANNOT PLAY." appears.)

Playback

- The time displayed may be different from the recording time and it may take time to display the thumbnail display when playing back motion pictures recorded on another product.
- The recording time is not displayed on the screen during playback of scenes recorded on other products.

Fast forward/rewind playback

Move and hold the joystick right during playback until fast-forward starts.

(Move and hold the joystick left to rewind.)

- Move the joystick again to increase the speed.
- Normal playback is restored when you move the joystick up.



Slow-motion playback

1 Move the joystick up during playback to pause the playback.

2 Move and hold the joystick right.

(Slow-motion pictures will be played back in reverse when you move and hold the joystick left.)

- Normal playback is restored when you move the joystick up.

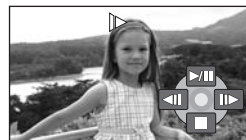

Frame-by-frame playback

The motion picture is advanced one frame at a time.

1 Move the joystick up during playback to pause the playback.

2 Move the joystick right.

(The frames will be advanced one at a time in the reverse direction when you move the joystick left.)

- Normal playback is restored when you move the joystick up.



To adjust the volume

Adjust the speaker volume during playback.

Move the volume lever to change the volume level.

Towards “+”: increases the volume

Towards “-”: decreases the volume

- The further the [] indicator moves to the right, the higher the volume level becomes.
- When the adjustment is completed, the volume setting display will disappear.

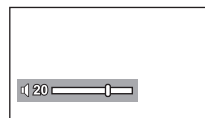

Playing back motion pictures by date

Recorded scenes are grouped by date on this unit.
Scenes recorded on the same day can be played back in succession.

1 Press the MENU button, then select [PLAY SETUP] → [PLAY MODE] → [BY DATE] and press the joystick.

- When [PLAY MODE] is set to [VIEW ALL], all recorded motion pictures will be played back in succession.

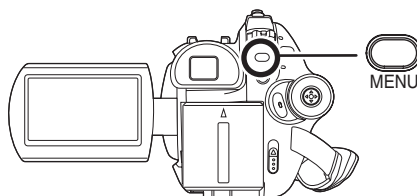

2 Select the date for playback, then press the joystick.

The scenes recorded on the same day are displayed as thumbnails.



3 Select the scene to be played back.

- Even if scenes are recorded on the same day, they are grouped separately in the following cases.
 - When the number of scenes exceeds 99 **RAM** **-RW(VR)** **-RW(V)** **-R**
 - When the disc is removed **-RW(V)** **-R**
 - When the [ASPECT] setting is changed **-RW(V)** **-R**
 - When the disc is repaired **-RW(V)** **-R**
 - When the layers switch on a DVD-R DL **-R**

Resuming the previous playback

Press the MENU button, then select [PLAY SETUP] → [RESUME PLAY] → [ON] and press the joystick.

If playback of a motion picture is stopped, [R] appears on the thumbnail view of the stopped scene.

- If playback is stopped at any point during a motion picture while [RESUME PLAY] is set to [OFF], the next time the motion picture is played back, it will be from the beginning.
- The resume position memorized is cleared if you open the disc cover or operate the mode dial, etc. (The [RESUME PLAY] setting is kept.)

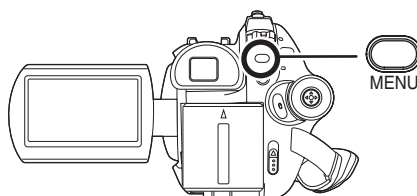

Still picture playback (JPEG still pictures)

SD

Play back the still pictures recorded on the card.

1 Rotate the mode dial to select .

The still pictures recorded on the SD card are displayed as thumbnails.

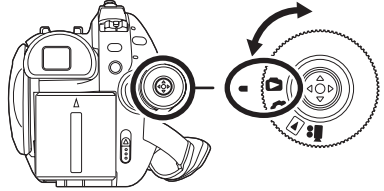

2 Select the file to be played back.

- A** File number
- B** Scroll bar display

The selected file will be encircled by a yellow frame.

- When 9 or more files have been recorded, the next (or previous) page is displayed by moving the joystick.
- If you move and hold the joystick up or down, you can advance 8 files at a time. The screen will not change at this time, but the file numbers and scroll bar display will change so release the joystick when you have arrived at the page with the file you want to display.

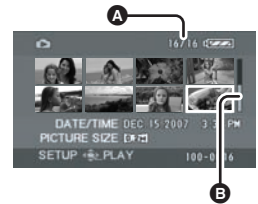





3 Press the joystick.

The selected file is played back on the full screen.
The operation icon is automatically displayed on the screen.



4 Move the joystick to operate.

- : Slide show (playback of the still pictures on the SD card in numerical order) start/pause.
- : Plays back the previous picture.
- : Plays back the next picture.
- : Stops the playback and shows the thumbnails.

■ About still picture compatibility

- This unit is compliant with the unified standard DCF (Design rule for Camera File system) established by JEITA (Japan Electronics and Information Technology Industries Association).
- The file format supported by this unit is JPEG. (Not all JPEG formatted files will be played back.)
- If a non-standard file is played back, the folder/file number may not be displayed.
- This unit may degrade or not play back data recorded or created on another product and another product may degrade or not play back data recorded on this unit.

- Do not operate the mode dial during the slide show.
- While this unit accesses the SD card (the access lamp is lit), do not remove the SD card.

- It takes time to display the file depending on the number of pixels of the file.
- When a file is displayed as [!] on the thumbnail display, playback is not possible.
- If you attempt to play back file recorded in a different format or file data is defective, an error message may appear.
- The time displayed may be different from the recording time and it may take time to display the thumbnail display when playing back still pictures recorded on another product.
- The power will not turn off when the LCD monitor and the viewfinder are closed and retracted.

Editing scenes

Deleting scenes

This is for deleting scenes recorded on discs.

RAM -RW(VR)

The deleted scenes cannot be restored.

- Scenes on DVD-RW (Video format) and DVD-R cannot be deleted.

Deleting scenes one at a time

◇ Rotate the mode dial to select .

1 Press the  button during playback.

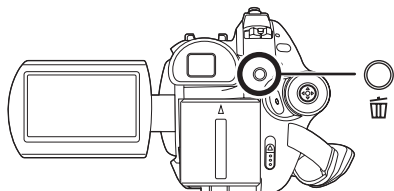

2 When the confirmation message appears, select [YES], then press the joystick.

Deleting multiple scenes from the thumbnail display

◇ Rotate the mode dial to select .

1 Press the  button in the thumbnail display.

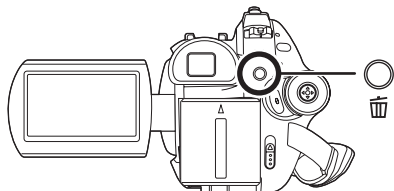

2 Select [SELECT] or [ALL] and press the joystick.

- When [ALL] is selected, the following scenes will be deleted. Proceed to step 5.
 - When [PLAY MODE] is set to [VIEW ALL]: All the scenes on the disc
 - When [PLAY MODE] is set to [BY DATE]: All the scenes selected by date

3 (Only when [SELECT] is selected in step 2) **Select the scene to be deleted, then press the joystick.**

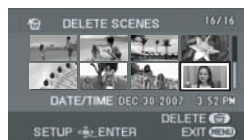

The selected scene is encircled by a red frame.

- When the joystick is pressed again, the selected scene will be canceled.
- Up to 8 scenes displayed on a page can be set in succession.

4 (Only when [SELECT] is selected in step 2) **Press the  button.**

5 When the confirmation message appears, select [YES], then press the joystick.

(Only when [SELECT] is selected in step 2)

To continue deleting other scenes

Repeat steps 3-5.

To complete editing

Press the MENU button.

- You can also delete scenes by pressing the MENU button, selecting [EDIT SCENE] → [DELETE] and then selecting [SELECT] or [ALL].
- To delete an unwanted part of a scene, divide the scene first, and then delete the unnecessary part. (→ 65)
- In case of [ALL], the deletion may take time if there are many scenes on the disc.

- Do not turn off this unit while deleting.
- When you delete scenes, use a battery with sufficient battery power or use the AC adaptor.
- It may not be possible to delete scenes that have been divided. Combine the divided scenes, and then delete them.

Dividing a scene

This is for dividing a scene into two.

RAM -RW(VR)

To delete an unnecessary portion of a scene, first divide the scene and then delete the unnecessary portion.

◇ Rotate the mode dial to select .

- 1 Press the MENU button, then select [EDIT SCENE] → [DIVIDE] → [YES] and press the joystick.

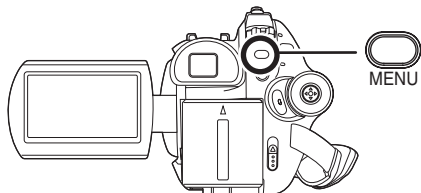

- 2 Select the scene to be divided, then press the joystick.



The selected scene is played back.

- 3 When you reach the area where you want to divide the scene,

move the joystick down to set the dividing point.



- Using slow-motion playback or frame-by-frame playback makes it easy to search for the point where you want to divide the scene. (→ 60)

- 4 When the confirmation message appears, select [YES], then press the joystick.

To continue dividing other scenes

Repeat steps 2-4.

To complete editing

Press the MENU button.

Combining scenes

This function is only for combining two consecutive scenes into one.

RAM -RW(VR)

◇ Rotate the mode dial to select .

- 1 Press the MENU button, then select [EDIT SCENE] → [COMBINE] → [YES] and press the joystick.

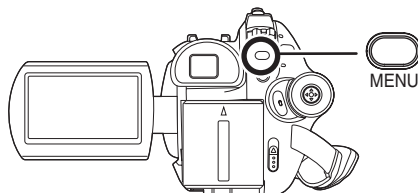

2 Select the scene to be combined, then press the joystick.

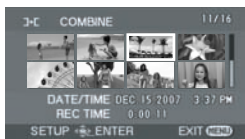

- The selected scene and the next scene are combined.
- If you wish to combine scenes that are not next to each other or scenes with different recording dates, first create a playlist and then combine the scenes on the playlist. (→ 66, 70)

3 When the confirmation message appears, select [YES], then press the joystick.

To continue combining other scenes

Repeat steps 2-3.

To complete editing

Press the MENU button.

Using playlists

What is a playlist?

You can create a playlist by gathering your favorites from the recorded scenes. Since the playlist is not created by copying data, you will consume little of the disc capacity by making a playlist.

- If you create or delete playlists, the original scenes will not be modified. Editing scenes on a playlist will not affect the original scenes.

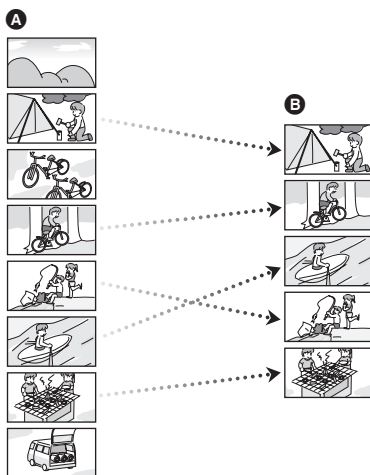

- A** Recorded scenes
- B** Playlist

- The maximum number of items on a disc (per side)
 - Playlists: 99
 - Playlist scenes: 999
- If original scenes are deleted, the portion of playlists created with these scenes is also deleted.

Creating a new playlist

RAM **-RW(VR)**

- ◇ Rotate the mode dial to select

- 1 Press the MENU button, then select [PLAY SETUP] → [PLAYLIST] → [CREATE] and press the joystick.

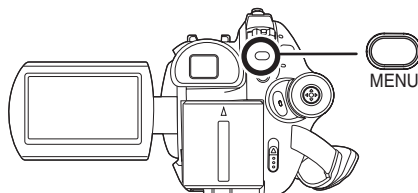

2 Select the scene to be added to the playlist, then press the joystick.

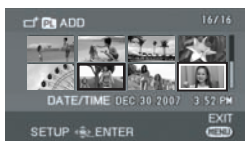

The selected scene is encircled by a red frame.

- When the joystick is pressed again, the selected scene will be canceled.
- Up to 50 scenes can be set in succession.
- The scenes are registered in the playlist in the order that they were selected. After creating a playlist, the order of the scenes in it can be changed with the [MOVE] function. (→ 69)

3 Press the MENU button.

4 When the confirmation message appears, select [YES], then press the joystick.

The thumbnail view screen of the created playlist is displayed.

To add another scene to the same playlist

Select [ADD]. (→ 68)

To playback a playlist

Select the scene to start playback, then press the joystick.

Playing back a playlist

RAM -RW(VR)

◇ Rotate the mode dial to select .

1 Press the MENU button, then select [PLAY SETUP] →

[PLAYLIST] → [VIEW LIST] and press the joystick.

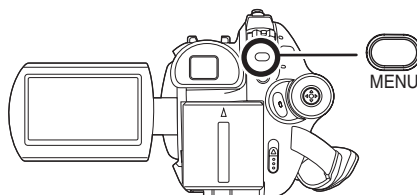

2 Select the playlist to be played back, then press the joystick.

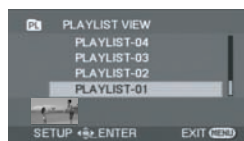

Scenes in the selected playlist are displayed as thumbnails.

3 Select the scene to start playback, then press the joystick.

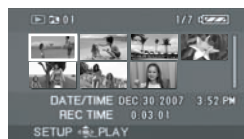

To select a different playlist

Press the MENU button, then select [PLAYLIST VIEW] and press the joystick.

To return to showing the original scenes

Press the MENU button, then select [END] and press the joystick.

Editing a playlist

RAM -RW(VR)

Editing scenes on a playlist will not affect the original scenes.

Deleting scenes

- Deleting scenes on a playlist will not affect the original scenes.

■ Deleting scenes one at a time

◇ Select playlist playback mode. (→ 67, steps 1 and 2)

1 Press the  button during playback.

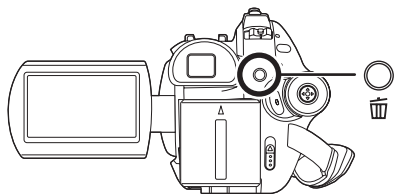

2 When the confirmation message appears, select [YES], then press the joystick.

■ Deleting multiple scenes from the thumbnail display

◇ Select playlist playback mode. (→ 67, steps 1 and 2)

1 Press the  button in the thumbnail display.

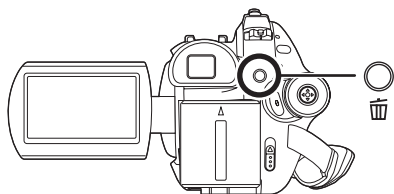

2 Select [SELECT] or [ALL] and press the joystick.

- When [ALL] is selected, the selected playlist will be erased. Proceed to step 5.

3 (Only when [SELECT] is selected in step 2)
Select the scene to be deleted, then press the joystick.

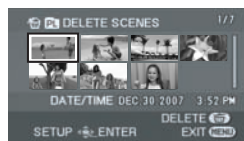

The selected scene is encircled by a red frame.

- When the joystick is pressed again, the selected scene will be canceled.
- Up to 8 scenes displayed on a page can be set in succession.

4 (Only when [SELECT] is selected in step 2)
Press the  button.

5 When the confirmation message appears, select [YES], then press the joystick.

(Only when [SELECT] is selected in step 2)

To continue deleting other scenes

Repeat steps 3-5.

To complete editing

Press the MENU button.

- You can also delete scenes by pressing the MENU button, selecting [EDIT] → [DELETE] and then selecting [SELECT] or [ALL].
- Deleting scenes on a playlist will not increase the remaining capacity for recording.
- The playlist itself is deleted if you delete all the scenes in it.
- When a playlist is deleted, the number of each subsequent playlist decreases by one.
- It may not be possible to delete scenes that have been divided. Combine the divided scenes, and then delete them.

Adding scenes to playlist

◇ Select playlist playback mode. (→ 67, steps 1 and 2)

- 1 Press the MENU button, then select [EDIT] → [ADD] → [YES] and press the joystick.

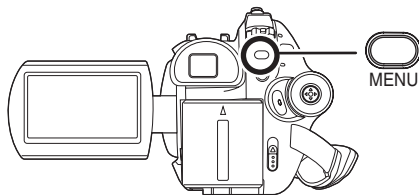

- 2 Select the scene to be added, then press the joystick.

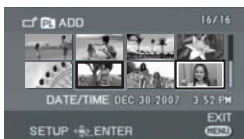

The selected scene is encircled by a red frame.

- When the joystick is pressed again, the selected scene will be canceled.
- Up to 50 scenes can be set in succession.
- The scenes are added to the playlist in the order that they were selected. The order of the scenes in the playlist can be changed by [MOVE] function. (→ 69)

- 3 Press the MENU button.

- 4 When the confirmation message appears, select [YES], then press the joystick.

The thumbnail view screen of the playlist that scenes were added to is displayed.

To continue adding scenes to the playlist

Repeat steps 1-4.

Moving scenes

The scenes in a playlist can be moved.

- ◇ Select playlist playback mode. (→ 67, steps 1 and 2)

- 1 Press the MENU button, then select [EDIT] → [MOVE] → [YES] and press the joystick.

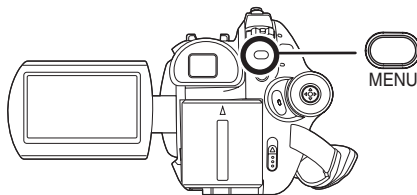

- 2 Select the scene to be moved, then press the joystick.

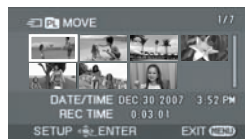

The selected scene is encircled by a red frame, and the position to insert is shown by a yellow bar.

- 3 Select the position to insert the scene, then press the joystick.

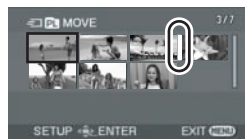

To continue moving other scenes in the playlist

Repeat steps 2-3.

To complete editing

Press the MENU button.

Dividing a scene

You can divide a scene into two parts.

- Dividing scenes on a playlist will not affect the original scenes.

- ◇ Select playlist playback mode. (→ 67, steps 1 and 2)

- 1 Press the MENU button, then select [EDIT] → [DIVIDE] → [YES] and press the joystick.

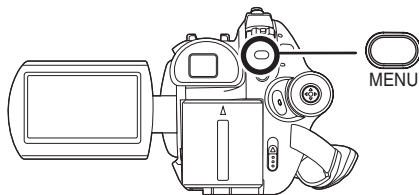

- 2 Select the scene to be divided, then press the joystick.

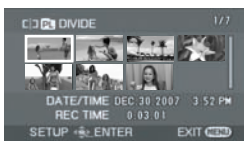

The selected scene is played back.

- 3 When you reach the area where you want to divide the scene, move the joystick down to set the dividing point.



- Using slow-motion playback or frame-by-frame playback makes it easy to search for the point where you want to divide the scene. (→ 60)

- 4 When the confirmation message appears, select [YES], then press the joystick.

To continue dividing other scenes

Repeat steps 2-4.

To complete editing

Press the MENU button.

Combining scenes

Two consecutive scenes can be combined into one.

- Combining scenes on a playlist will not affect the original scenes.

- ◆ Select playlist playback mode. (→ 67, steps 1 and 2)

- 1 Press the MENU button, then select [EDIT] → [COMBINE] → [YES] and press the joystick.

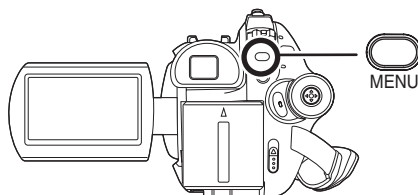

- 2 Select the scene to be combined, then press the joystick.

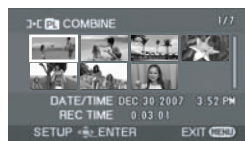

- The selected scene and the next scene are combined.

- 3 When the confirmation message appears, select [YES], then press the joystick.

To continue combining other scenes

Repeat steps 2-3.

To complete editing

Press the MENU button.

Editing still pictures

Deleting still pictures

This is for deleting still picture files recorded on SD cards.

SD

The deleted files cannot be restored.

Deleting files one at a time

◇ Rotate the mode dial to select .

1 Press the  button during playback.

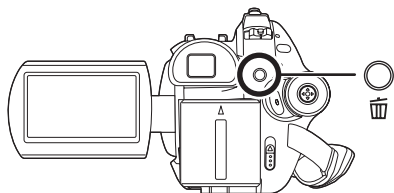

2 When the confirmation message appears, select [YES], then press the joystick.

Deleting multiple files from the thumbnail display

◇ Rotate the mode dial to select .

1 Press the  button in the thumbnail display.

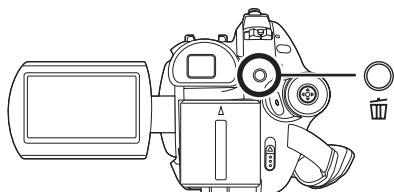

2 Select [SELECT] or [ALL] and press the joystick.

- When [ALL] is selected, all files on the SD card except the locked files will be erased. Proceed to step 5.

3 (Only when [SELECT] is selected in step 2) **Select the file to be deleted, then press the joystick.**

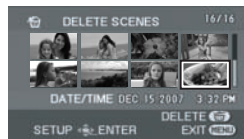

The selected file is encircled by a red frame.

- When the joystick is pressed again, the selected file will be canceled.
- Up to 8 files displayed on a page can be set in succession.

4 (Only when [SELECT] is selected in step 2) **Press the  button.**

5 When the confirmation message appears, select [YES], then press the joystick.

(Only when [SELECT] is selected in step 2)

To continue deleting other files

Repeat steps 3-5.

To complete editing

Press the MENU button.

■ Deleting still picture files recorded on an SD card by other products

A still picture file (other than JPEG) that cannot be played back on this unit may be erased.

- You can also delete files by pressing the MENU button, selecting [PICT. SETUP] → [DELETE] and then selecting [SELECT] or [ALL].
- In case of [ALL], the deletion may take time if there are many files on the SD card.
- Do not turn off this unit while deleting.
- When you delete files, use a battery with sufficient battery power or use the AC adaptor.
- Do not remove the SD card while deleting.

- If files conforming to DCF standard are deleted, all the data related to the files will be deleted.

Locking still pictures

This is for preventing still picture files from being deleted by mistake.

SD

Still picture files recorded on an SD card can be locked so that they are not deleted by mistake. (However even if you lock some files on an SD card, formatting the card will delete all the files.)

- ◇ Rotate the mode dial to select .

- 1 Press the MENU button, then select [PICT. SETUP] → [LOCK] → [YES] and press the joystick.

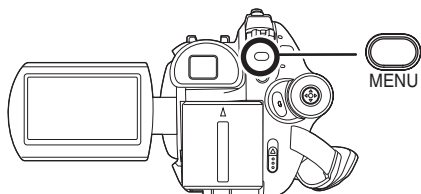

- 2 Select the file to be protected, then press the joystick.

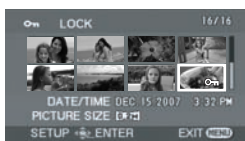

[] display appears and the selected file is locked.

- Press the joystick again to release the lock setting.
- You can also select multiple files in succession.

To complete the settings

Press the MENU button.

DPOF setting

This is for writing the printing data on an SD card.

SD

You can write the data of the still pictures to be printed and the number of prints (DPOF data) onto the SD card.

- ◇ Rotate the mode dial to select .

- 1 Press the MENU button, then select [PICT. SETUP] → [DPOF SET] → [SET] and press the joystick.

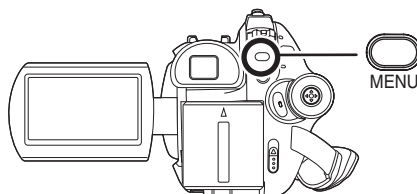

- 2 Select the file to be set, then press the joystick.



The number of prints set to be in DPOF is displayed.

- 3 Move the joystick up or down to select the number of prints, then press the joystick.

- You can select from 0 to 999. (The selected number of pictures can be printed with the printer supporting DPOF.)
- To cancel the setting, set the number of prints to [0].
- You can also select multiple files in succession.

To complete the settings

Press the MENU button.

To cancel all DPOF settings

Press the MENU button, then select [PICT. SETUP] → [DPOF SET] → [CANCEL ALL] and press the joystick.

- When the confirmation message appears, select [YES], then press the joystick.

■ What is DPOF?

DPOF stands for Digital Print Order Format. This enables picture printing information to be written onto an SD card so that it can be used on a system supporting DPOF.

-
- The DPOF setting can be established for up to 999 files.
 - DPOF setting made on other devices may not be recognized by this unit. Please perform the DPOF settings on this unit.
 - You cannot add the recording date to pictures to be printed with the DPOF settings.

Disc management

Finalizing a disc

It allows the discs to be played on other devices.

-RW(VR) -RW(V) -R

If you insert a DVD-RW or a DVD-R disc recorded in this unit (that has not been finalized) into another device such as DVD recorder, computer, etc., the disc may become unusable.

Be sure to finalize the disc on this unit before inserting it in other devices.

DVD-RAM:

- It is not necessary to finalize DVD-RAM.

DVD-RW (VR format):

- DVD-RW (VR format) after finalization can be recorded and edited in the same way as DVD-RW (VR format) before finalization.
- After finalizing a DVD-RW (VR format) once, you cannot finalize it again. (Even if you record on or edit a DVD-RW (VR format) after finalizing, it is not necessary to finalize it again.)

DVD-RW (Video format), DVD-R:

- After finalizing, the disc becomes play-only and you can no longer record.
- When you un-finalize a DVD-RW (Video format), the disc can be used for recording again. (→ 75)

◇ Rotate the mode dial to select .

1 Connect this unit to the AC adaptor.

- Finalization cannot be executed when using a battery. If the power supply stops while finalizing, the finalization will fail and the data may be damaged. Use the AC adaptor.

2 Press the MENU button, then select [DISC SETUP] →

[FINALIZE] → [YES] and press the joystick.

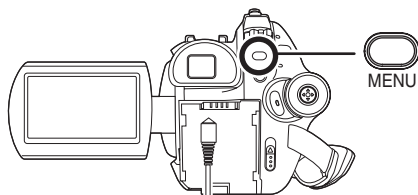

3 When the confirmation message appears, select [YES], then press the joystick.

When finalizing a DVD-RW (Video format) or DVD-R, a top menu containing thumbnails is created.

- When finalizing is complete, press the MENU button to exit the message screen.
- Do not finalize a disc recorded on this unit using any other device.
- In the case of a double sided disc, finalize each side.
- The top menu created when finalizing does not appear on this unit. Play back the disc on a DVD player.

Titles are displayed by recording date on the top menu. However, when [PLAY MODE] is set to [BY DATE] to view scenes by recording date, some scenes recorded on the same date may be separated. (→ 61) These scenes will be displayed as separate titles on the top menu.
- It may take time to finalize a disc.
- If this unit becomes hot or is shaken strongly or impacted while finalizing, the finalization will fail and the disc may become unplayable on other devices.
- If the power supply stops while finalizing, the finalization will fail and the disc may become unplayable on other devices even if disc repair is carried out.

Un-finalizing a DVD-RW

This is for un-finalizing a DVD-RW (Video format) so that it can be used for recording.

-RW(V)

◇ Rotate the mode dial to select .

- 1 Press the MENU button, then select [DISC SETUP] → [UN-FINALIZE] → [YES] and press the joystick.

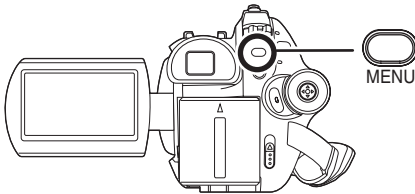

2 When the confirmation message appears, select [YES], then press the joystick.

- When un-finalizing is complete, press the MENU button to exit the message screen.
- DVD-RW (VR format) cannot be un-finalized. DVD-RW (VR format) after finalization can be recorded and edited in the same way as DVD-RW (VR format) before finalization.
- DVD-R cannot be un-finalized.
- When you un-finalize the disc, use a battery with sufficient battery power or the AC adaptor.

Protecting a disc

RAM -RW(VR)

This is for preventing recorded contents from being deleted or edited by mistake. Further recording and editing is not possible on protected discs until the protection is released.

◇ Rotate the mode dial to select .

- 1 Press the MENU button, then select [DISC SETUP] →

[DISC PROTECT] and press the joystick.

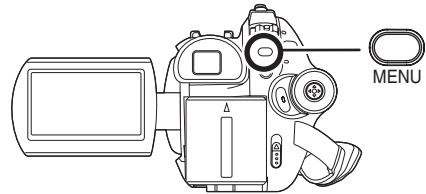

- 2 When the confirmation message appears, select [YES], then press the joystick.

To release disc protection



- 1) Press the MENU button, then select [DISC SETUP] → [DISC PROTECT] and press the joystick.
 - 2) When the confirmation message appears, select [YES], then press the joystick.
- If the disc has been protected on another device, it may not be possible to release the protection on this unit. In this case, release the protection on the device that you used to protect it.

Formatting discs

This is for initializing discs.

RAM -RW(VR) -RW(V)

Please be aware that if a disc is formatted, then all the data recorded on the disc will be erased.

◇ Rotate the mode dial to select  or .

- 1 Press the MENU button, then select [DISC SETUP] → [FORMAT DISC] → [YES] and press the joystick.

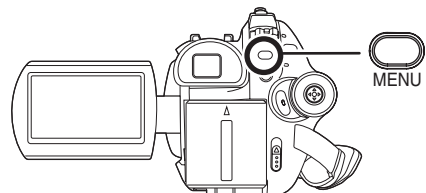

- When formatting a DVD-RAM, skip to step 3.

2 (When formatting a DVD-RW only)

Select format type (→ 21), then press the joystick.



3 When the confirmation message appears, select [YES], then press the joystick.

- When formatting is complete, press the MENU button to exit the message screen.
- In the case of a double sided disc, format each side.
- It may not be possible to format a disc with many scratches or dirt. Such discs cannot be used.
- During formatting, do not turn this unit off.
- When you format the disc, use a battery with sufficient battery power or the AC adaptor.

Formatting DVD-RAM:

- We recommend formatting on this unit. If formatting on a computer, use the supplied software. For more details, refer to the operating instructions of the software. If you connect this unit to a computer to format a DVD-RAM, you cannot use DVDForm (→ 83) to physically format it. Use a separate DVD-RAM drive to physically format a DVD-RAM.

Formatting DVD-RW:

- Format on this unit.

Displaying disc information

RAM -RW(VR) -RW(V) -R

Information such as the number of recorded scenes, the remaining space and whether or not the disc is finalized or protected is displayed.

- ◇ Rotate the mode dial to select or .

Press the MENU button, then select [DISC SETUP] → [INFORMATION] → [YES] and press the joystick.

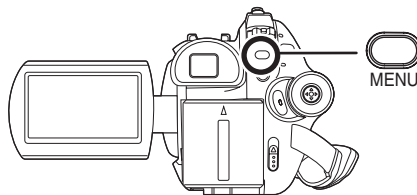

To exit the information screen

Press the MENU button.

Card management

Formatting an SD card

This is for initializing cards.

SD

Please be aware that if an SD card is formatted, then all the data recorded on the card will be erased. Store important data on a computer, etc.

- ◇ Rotate the mode dial to select or .

- 1 Press the MENU button, then select [SETUP] → [FORMAT CARD] → [YES] and press the joystick.

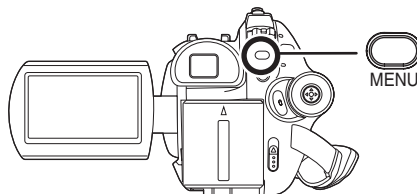

- 2 When the confirmation message appears, select [YES], then press the joystick.

- When formatting is complete, press the MENU button to exit the message screen.

- Use this unit to format SD cards. If an SD card is formatted on other products (such as a computer), the time spent for recording may become longer and you may not be able to use the SD card.
- Depending on the type of SD card being used, it may take time to format.
- During formatting, do not turn this unit off.
- When you format the SD card, use a battery with sufficient battery power or the AC adaptor.
- Do not remove the SD card while formatting.

With a TV

Playback on TV

RAM -RW(VR) -RW(V) -R SD

The motion pictures and still pictures recorded by this unit can be played back on a TV.

- Use the AC adaptor to free you from worrying about the battery running down.

1 Connect this unit and a TV.

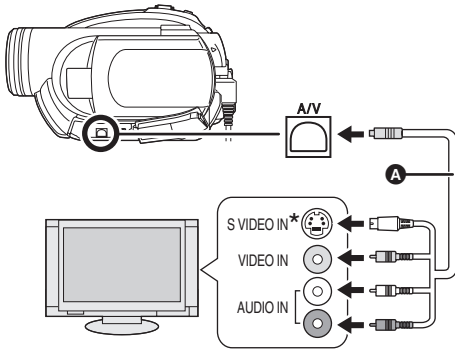

A AV/S cable (supplied)

- Insert the plugs as far as they will go.

* If the TV has an S Video terminal, also connect the S Video plug to it. This allows you to enjoy more beautiful pictures.

2 Turn on this unit, then rotate the mode dial to select or .

3 Change the input channel on the TV.

- The channel set will differ depending on the terminal to which the unit is connected.

4 Start playback on this unit.

The image and audio are output on the TV.

■ If the image or audio from this unit is not output on the TV

- Check that the plugs are inserted as far as they go.
- Check the connected terminal.
- **Check the TV's input setting (input switch).** (For more information, please read the **operating instructions for the TV.**)



- If the images are not displayed correctly on a wide-screen TV, adjust the aspect setting on the TV. (Refer to the operating instructions of the TV for details.) If the pictures are displayed squeezed horizontally on a regular TV (4:3), change the [TV ASPECT] setting on this unit. (→ below)

■ To watch images with a 16:9 aspect ratio on a regular TV (4:3)

When playing back motion pictures recorded with a 16:9 aspect ratio ([ASPECT] was set to [16:9]) or still pictures recorded with a 16:9 aspect ratio ([PICTURE SIZE] was set to [0.2m]) on a TV with a 4:3 aspect ratio, the images may be squeezed horizontally. In this case, change the menu setting to play back the pictures in the original aspect ratio. (Depending on the TV setting, the pictures may not be displayed correctly. For more information, please read the operating instructions of your TV.)

Press the MENU button, then select [SETUP] → [TV ASPECT] → [4:3] and press the joystick.

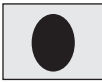
Example of images with a 16:9 aspect ratio on a regular TV (4:3)

[TV ASPECT] setting	
[16:9]	[4:3]
	

- This function's default setting is [16:9].

With a DVD recorder/ player

Playback on DVD recorder, DVD player, computer etc.

- Do not insert a DVD-RW or a DVD-R disc recorded in this unit (that has not been finalized) into another device such as DVD recorder, DVD player, computer, etc. as the disc may become unusable.
- If you insert a DVD-RW disc recorded in this unit (that has not been finalized) into another device such as DVD recorder, computer, etc., a format message may appear. Do not format the disc as all the important data recorded on the disc will be erased and cannot be recovered.
- When playing back a disc on a DVD recorder/player, place the device so that the disc lies flat.

Playing back a DVD-RAM or a DVD-RW (VR format)

RAM -RW(VR)

- 1 [Only when playing back a DVD-RW (VR format)]
Finalize the disc on this unit.
(→ 74)

- 2 **Insert the disc in the playback device and then play it back.**

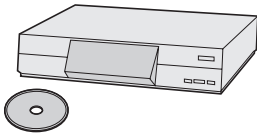

- Playback is only possible on devices that support 8 cm (3") DVD-RAM or DVD-RW (VR format). Refer to the operating instructions of the playback device.
- You cannot record images that allow "One time only recording" on a 8 cm (3") disc.

Playing back a DVD-RW (Video format) or a DVD-R

-RW(V) -R

- 1 **Finalize the disc on this unit.**
(→ 74)

- 2 **Insert the disc in the playback device and then play it back.**

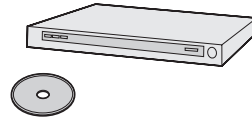

- Playback is possible on devices that support 8 cm (3") DVD-Video, but playback on all DVD players is not guaranteed.
- Playback of DVD-R DL is only possible on devices that support 8 cm (3") DVD-R DL. Refer to the operating instructions of the playback device.
- The recording time is not displayed.

Copying (dubbing) recordings onto a DVD recorder's hard disk

RAM -RW(VR) -RW(V) -R

If you have a DVD recorder with hard disk, images recorded by this unit can be stored on the hard disk.

- Do not insert a DVD-RW or a DVD-R disc recorded in this unit (that has not been finalized) into the DVD recorder as the disc may become unusable.
- If you insert a DVD-RW disc recorded in this unit (that has not been finalized) into the DVD recorder, a format message may appear. Do not format the disc as all the important data recorded on the disc will be erased and cannot be recovered.
- If you want to record (dub) a disc that the DVD recorder is not compatible with, connect this unit and the DVD recorder with the AV/S cable and then record (dub) the disc. (→ 80)

- 1** [Only when you record (dub) a DVD-RW or a DVD-R]
Finalize the disc on the unit.
(→ 74)

2 Insert the disc in the DVD recorder, then copy (dub) the contents onto the hard disk.

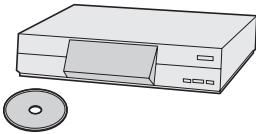

- For details on how to copy (dub) the images onto the hard disk, refer to the operating instructions of the DVD recorder.
- If your DVD recorder has an SD card slot, you can write the still picture files recorded on an SD card with this unit to a disc or the hard disk.
- You cannot record images that allow “One time only recording” on a 8 cm (3”) disc.
- If you copy (dub) images recorded on a DVD-RW (Video format) or a DVD-R disc, the title name of the images after copying (dubbing) becomes the date they were dubbed.

If you record (dub) images directly from the disc or with the AV/S cable and then play them back on a wide-screen TV, they may be squeezed horizontally. In this case, refer to the operating instructions of the device you are recording (dubbing) to or read the operating instructions of the wide-screen TV and set the aspect setting to 16:9 (Full).

With a VCR

Recording (dubbing) images onto other video devices

RAM -RW(VR) -RW(V) -R

You can record (dub) images played back on this unit onto other video devices.
You can create a playlist by gathering the scenes you want to record (dub), then record (dub) the scenes in this playlist only to other devices.
(→ 66)

- Use the AC adaptor to free you from worrying about the battery running down.

1 Connect this unit and a video device.

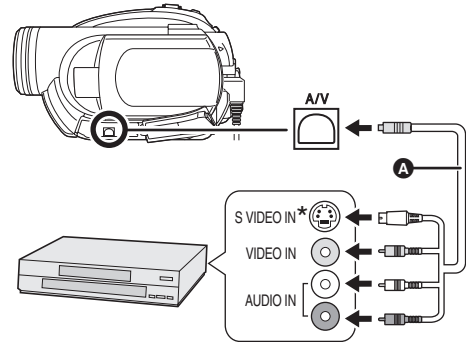

- A** AV/S cable (supplied)
- Insert the plugs as far as they will go.

* If the video device has an S Video terminal, also connect the S Video plug into it. This allows you to enjoy more beautiful pictures.

2 Turn on this unit, then rotate the mode dial to select .

3 Change the input channel on the video device and TV.

- The channel set will differ depending on the terminal to which the unit is connected.

4 Start playback on this unit. Then start recording on the connected device.

- See the operating instructions of the video device for details.

To stop recording (dubbing)

Stop recording on the connected device.
Then stop playback on this unit.

With a printer (PictBridge)

SD

To print pictures by directly connecting this unit to the printer, use a printer compatible with PictBridge. (Read the operating instructions for the printer.)

- Use the AC adaptor to free you from worrying about the battery running down.

◇ **Insert an SD card with recorded images in the unit, then turn on the unit.**

1 Connect this unit and a printer.

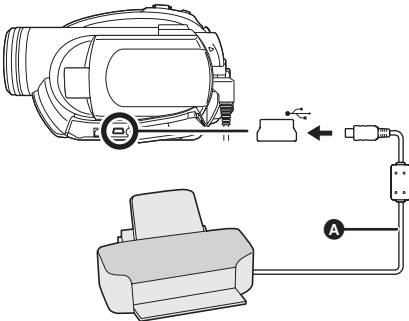

- Ⓐ USB cable (supplied)
- Insert the plugs as far as they will go.
- Do not use any other USB cables except the supplied one. (Operation is not guaranteed with any other USB cables.)

The USB function selection screen will appear.

2 Select [PictBridge] and press the joystick.

The [PictBridge] indication appears on this unit's screen.

3 Select a file to be printed, then press the joystick.



The number of pictures set is displayed.

4 Move the joystick up or down to select the desired number of prints, then press the joystick.

- You can set up to 9 prints.
- To cancel the setting, set the number of prints to [0].
- Up to 8 files displayed on a page can be set in succession by repeating steps 3 and 4.

5 Press the MENU button to display the PictBridge menus.

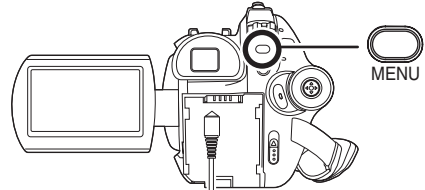

6 Select the date print setting on [DATE PRINT].

- If the printer is not capable of date printing, this setting is unavailable.

7 Select the paper size setting on [PAPER SIZE].

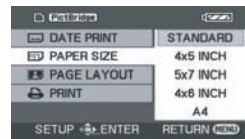

[STANDARD]: Size specific to the printer

[4×5 INCH]: L size

[5×7 INCH]: 2L size

[4×6 INCH]: Postcard size

[A4]: A4 size

- You cannot set paper sizes not supported on the printer.

8 Select the layout setting on [PAGE LAYOUT].



[STANDARD]: Layout specific to the printer

[]: No frame print

[]: Frame print

- You cannot set page layouts not supported on the printer.

9 Select [PRINT] → [YES] and press the joystick.

The pictures are printed.

- Exit PictBridge by disconnecting the USB cable after the pictures have been printed.

When you want to stop printing halfway

Move the joystick down.

A confirmation message appears. If [YES] is selected, the number of prints set is canceled and the screen returns to step 3. If [NO] is selected, all the settings are kept and the screen returns to step 3.

- Avoid the following operations during printing. These operations disable proper printing.
 - Disconnecting the USB cable
 - Removing the SD card
 - Switching the mode dial
 - Turning off the power
- Check the settings for the paper size, quality of print, etc. on the printer.
- The sides of pictures recorded when [] is set may be cut at printing. Check before printing.

When using a printer with a trimming or borderless printing function, cancel this function before printing. (Refer to the operating instructions of the printer for details.)

- You may not be able to print still pictures recorded with other products.
- When the unit is connected directly to the printer, the DPOF settings cannot be used.
- Connect the printer directly to this unit. Do not use a USB hub.

Before using with a computer

Contents on provided CD-ROM

The following software applications are contained on the provided CD-ROM.

■ DVD-RAM Driver

This is necessary to configure the unit as a drive on a computer.

DVDForm:

This is used to format DVD-RAM on a computer.

■ Acrobat Reader

To view the installed operating instructions, Adobe Acrobat Reader 5.0 or later is required.

If the Adobe Acrobat Reader is not already installed on your computer, you can install it from the CD-ROM. Click the [Acrobat Reader] in [Setup Menu], and follow the on-screen messages to install.

Operating environment

- A CD-ROM drive is necessary to install the supplied software applications.
- When 2 or more USB devices are connected to a computer, or when devices are connected through USB hubs or by using extension cables, proper operation is not guaranteed.
- Use the supplied USB cable when connecting to the computer. (Operation is not guaranteed with any other USB cables.)

■ DVD-RAM Driver

Personal computer	IBM PC/AT compatible personal computer
OS	Microsoft Windows 2000 Professional Microsoft Windows XP Home Edition Microsoft Windows XP Professional
CPU	Intel Pentium III 450 MHz or higher

■ Using Built-in SD Drive

Personal computer	IBM PC/AT compatible personal computer
OS	Microsoft Windows 2000 Professional Microsoft Windows XP Home Edition Microsoft Windows XP Professional
CPU	Intel Pentium II 300 MHz or higher
RAM	32 MB or more (64 MB or more recommended)
Interface	USB 1.1 or later — A type

- The USB equipment operates with the driver installed as standard in the OS.

End User License Agreement

Before opening the CD-ROM package, please read the following.

You ("Licensee") are granted a license for the Software defined in this End User Software Agreement ("Agreement") on condition that you agree to the terms and conditions of this Agreement. If Licensee does not agree to the terms and conditions of this Agreement, promptly return the Software to Matsushita Electric Industrial Co., Ltd. ("Matsushita"), its distributors or dealers from which you made the purchase.

Article 1 License

Licensee is granted the right to use the software, including the information recorded or described on the CD-ROM, instruction manuals, and any other media provided to Licensee (collectively "Software"), but all applicable rights to patents, copyrights, trademarks and trade secrets in the Software are not transferred to Licensee.

Article 2 Use by a Third Party

Licensee may not use, copy, modify, transfer or allow any third party, whether free of charge or not, to use, copy or modify the Software, except as expressly provided for in this Agreement.

Article 3 Restrictions on Copying the Software

Licensee may make a single copy of the Software in whole or in part solely for back-up purposes.

Article 4 Computer

Licensee may only use the Software on a single computer at a single location.

Article 5 Reverse Engineering, Decompiling or Disassembly

Licensee may not reverse engineer, decompile, or disassemble the Software, except to the extent either of them is permitted under law or regulation of the country where Licensee resides. Matsushita, or its distributors or dealers will not be responsible for any defects in the Software or damage to Licensee caused by Licensee's

reverse engineering, decompiling, or disassembly of the Software.

Article 6 Limitation of Liability

The Software is provided "AS-IS" without warranty of any kind, either expressed or implied, including, but not limited to, warranties of non-infringement, merchantability and/or fitness for a particular purpose. Further, Matsushita does not warrant that the operation of the Software will be uninterrupted or error free. Matsushita or any of its distributors or dealers will not be liable for any damage suffered by Licensee arising from or in connection with Licensee's use of the Software.

Article 7 Export Control

Licensee agrees not to export or re-export to any country the Software in any form without the appropriate export licenses under regulations of the country where Licensee resides, if necessary.

Article 8 Termination of License

The right granted to Licensee hereunder will be automatically terminated if Licensee violates any of the terms and conditions of this Agreement. Upon such automatic termination, Licensee must destroy the Software and related documentation together with all the copies thereof at Licensee's own expense.

Installation

When installing the software, log on to your computer as the Administrator or with a user name with equivalent authorization. (If you do not have authorization to do this, consult your manager.)

Do not connect the USB cable before installing the DVD-RAM Driver. If the DVD-RAM Driver is installed after connecting this unit and the computer with the USB cable, this unit may not be correctly recognized by the computer. (The DVD-RAM Driver has a driver for USB connection.)

- Before starting the installation, close any other software applications which are running.
- Do not perform any other operations on your computer while the software is being installed.
- If another DVD-RAM Driver is already installed in your computer, check this DVD-RAM Driver. If packet writing software which supports DVD-RAM discs is installed, it is necessary to uninstall it and then install the provided DVD-RAM Driver.

Installing DVD-RAM Driver

1 Insert the CD-ROM into the computer.

The [Setup Menu] screen will appear.

- If the [Setup Menu] screen does not appear, double-click the CD-ROM drive icon in [My Computer].

2 Click [DVD-RAM Driver].

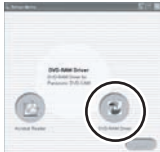

- The software application may not run properly if you cancel the installation at any point (e.g. by pressing [Cancel]).

3 Click [Driver and Formatter Setup].

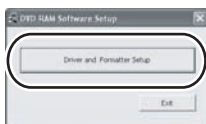

- If an [Information] or [Question] message appears, continue following the on-screen messages for installation.

4 Click [Next].



5 Read carefully through the End User License Agreement (→ 84), then click [Yes].



- You cannot install the application if you click [No].

6 Click [Next].

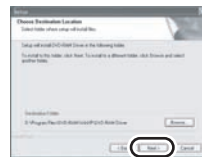

Continue to follow the on-screen messages to install it.

7 When installation is complete, some notes will appear:

Check the contents, then click [X] at the top right of window.



8 Click [Finish].



Windows 2000 only:

The detection of device will start, after which it will take several minutes for the computer to detect the device. When detecting the device is complete, a message that prompts you to reboot will appear:

Click [Yes].

The computer must be rebooted for the driver to work.

■ If any trouble has occurred while installing DVD-RAM Driver:

When [Block] is selected in the [Driver Signing Options] in the [System Properties], the installation procedure will not complete. Select [Warn] and try again.

To check and change the setting, select [start] → ([Settings] →) [Control Panel] → ([Performance and Maintenance] →) [System] and select [Driver Signing] of the [Hardware] tab.

■ About the [RAMASST] support tool:

[RAMASST] is a support tool for Windows XP that disables the drive's CD writing function so that data can be written from a computer to a DVD-RAM.

When you install the DVD-RAM Driver, [RAMASST] is automatically installed and displayed in [Startup].

Reading the operating instructions of the software applications

For details on how to use the software applications, read the PDF instructions.

- You will need Adobe Acrobat Reader 5.0 or later to read the PDF operating instructions. (→ 83)

■ DVD-RAM Driver

Select [start] → [All Programs (Programs)] → [DVD-RAM] → [DVD-RAM Driver] → [Using DVD-RAM disc].



Software application uninstallation

Follow the steps below to uninstall any software applications that you no longer require.

- 1 Select [start] → ([Settings] →) [Control Panel] → [Add or Remove Programs (Applications)].

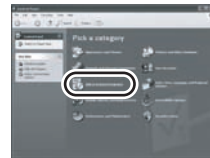

- 2 Select the software application to be deleted, then click [Change/Remove] ([Change or Remove] or [Add/Remove]).



- Proceed with the uninstallation by following the on-screen instructions.
- After uninstalling the software, be sure to reboot the computer.

Connection and recognition

Connection and recognition procedures

After the driver and software applications are installed, the unit must be connected to the computer and be correctly recognized by the computer.

- Connect after installing the driver and software applications.
- If the supplied CD-ROM is inserted in the computer, remove it. (If the [Setup Menu] is running, wait until it finishes, then remove the CD-ROM.)
- If the recognition procedure is not accomplished properly, operation will not be possible after connecting the unit to the computer.
- If the unit fails to operate normally, it may mean that you have not conducted the installation or recognition procedure properly.
- **Be sure to finalize DVD-RW (VR format), DVD-RW (Video format) and DVD-R on this unit, before using them on the computer. Un-finalized discs will not be recognized by the computer.**

◇ Connect this unit to the AC adaptor.

- 1 Insert a disc or card with recorded images in the unit, then turn on the unit.**

2 Connect this unit and a computer.

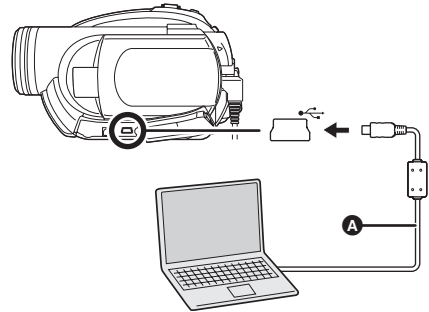

- A** USB cable (supplied)
- Insert the plugs as far as they will go. The unit and computer will not operate properly if the plugs are not inserted fully.
 - Do not use any other USB cables except the supplied one. (Operation is not guaranteed with any other USB cables.)

The USB function selection screen will appear.

3 Select [PC CONNECT(DISC)] or [PC CONNECT(CARD)] and press the joystick.

This unit is automatically recognized by the computer.

- **When the unit is connected to a computer, its power cannot be turned off.**
In this case, disconnect the USB cable (→ 89).
- If the unit is connected to a computer when the USB function is set to [PC CONNECT(DISC)], no image will appear on the LCD monitor or the viewfinder.
- When this unit is connected to a computer, you cannot use this unit's DISC EJECT lever to remove a disc. Use Windows Explorer to right-click the drive icon for this unit and select [Eject].
- When a computer is accessing a disc or card in this unit, the ACCESS/PC lamp or card access lamp lights. (When a card is being accessed,  appears on the LCD monitor.) Do not disconnect the USB cable or AC adaptor while the disc or card is being accessed as it may damage the data.

With a computer

- The disc and card cannot be accessed simultaneously.
- It may be necessary to reboot the computer after connecting this unit to it for the first time.

About the computer display

When the unit is connected to a computer, it is recognized as an external drive.

- Depending on the operating environment of the computer, the shape of the drive icon and the drive name (Example: E:) will differ.

■ When accessing the disc

Windows XP:

Optical disc drive is displayed in [My Computer].



Windows 2000:

[Removable Disk] and optical disc drive are displayed in [My Computer].

- When a DVD-RAM or DVD-RW (VR format) is inserted in this unit, it can be accessed from the removable disk drive.



- When a DVD-RW (Video format) or DVD-R is inserted in this unit, it can be accessed from the optical disc drive.



Example folder structure of a DVD-RAM or DVD-RW (VR format):

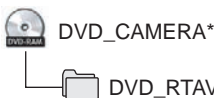

- DVD video recording format motion pictures are stored in the [DVD_RTAV] folder.

Example folder structure of a DVD-RW (Video format) or DVD-R:

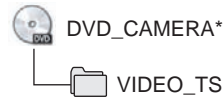

- DVD-Video format motion pictures are stored in the [VIDEO_TS] folder.

- * Depending on the maker of the disc and the device used to format it, the name displayed will differ.

Do not move or change the name of the folders and files recorded on this unit by Windows Explorer etc.

■ When accessing the card

[Removable Disk] is displayed in [My Computer].

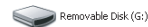

Example folder structure of an SD card:

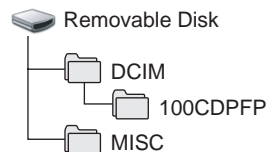

- JPEG format still pictures (IMGA0001.JPG etc.) are stored in the [100CDPFP] folder. These can be opened with picture software that supports JPEG pictures.
- Up to 999 files can be recorded in the [100CDPFP] or other such folder.
- The DPOF setting files are recorded in the [MISC] folder.

- Do not use the computer to delete the SD card's folders. Otherwise, it may no longer be possible for this unit to read the SD card.
- Always use this unit to format SD cards.
- When data not supported by this unit has been recorded on a computer, it will not be recognized by this unit.

To disconnect USB cable safely

1 Double click the icon in task tray.

Hardware disconnect dialog appears.

- Depending on your computer's settings, this icon may not be displayed.

2 Select [USB Mass Storage Device] and click [Stop].

3 Verify [MATSHITA DVD-RAM LMXK1987 USB Device] or [MATSHITA DVD Cam USB Device] is selected and click [OK].

Click [Close], and you can safely disconnect the cable.

- If you disconnect the USB cable while the access lamp is on or while  appears on the LCD monitor, it may damage the data.

Verifying the unit is correctly recognized by the computer

To verify the unit is correctly recognized by the computer, select the unit's mode, connect the unit to the computer via the USB cable and then follow the steps below.

- With some computers including those made by NEC, the Device Manager may not be displayed if a mode that places restrictions on the functions has been established. Consult the manufacturer or follow the steps in your computer's operating instructions to establish a mode in which all the functions can be used, then proceed with operation.

1 Select [start] → ([Settings] →) [Control Panel] → ([Performance and Maintenance] →) [System].



2 Click the [Hardware] tab, then click [Device Manager].



3 Verify the following items are displayed.



■ If the driver has been recognized properly

When using a disc:

Windows XP:

- [MATSHITA DVD-RAM LMXK1987 USB Device] is displayed at [DVD/CD-ROM drives].
- [USB Mass Storage Device] is displayed at [Universal Serial Bus controllers].

Windows 2000 Professional:

- [MATSHITA DVD-RAM LMXK1987 USB Device] is displayed at [DVD/CD-ROM drives].
- [MATSHITA DVD-RAM LMXK1987 USB Device] is displayed at [Disc drives].
- [USB Mass Storage Device] is displayed at [Universal Serial Bus controllers].

When using a card:

[USB Mass Storage Device] is displayed at [Universal Serial Bus controllers].

■ If the driver has not been recognized properly

[!] or [Unknown device] appears at [Universal Serial Bus controllers] or [Other devices], etc. (Where the display will appear depends on the type of computer you are using.)

You can use the following method to enable it to be recognized.

Method 1: Turn off the unit and your computer once and try again.

Method 2: Eject the disc or SD card from the unit and try again.

Method 3: Try connecting the unit to another USB port on your computer.

Menus

Menu list

Motion picture recording menus

BASIC	
SCENE MODE	OFF
GUIDE LINES	OFF
REC MODE	SP
ASPECT	16:9
CLOCK SET	NO
SETUP +> ENTER	EXIT (EXIT)

■ [BASIC]

[SCENE MODE] (→ 54)

[GUIDE LINES] (→ 52)

[REC MODE] (→ 43)

[ASPECT] (→ 53)

[CLOCK SET] (→ 38)

■ [ADVANCED]

[D.ZOOM] (→ 48)

[O.I.S.] (→ 53)

[FADE COLOR] (→ 51)

[WIND CUT] (→ 54)

[ZOOM MIC] (→ 48)

■ [DISC SETUP]

[FORMAT DISC] (→ 75)

[INFORMATION] (→ 76)

■ [SETUP]

[DISPLAY] (→ 92)

[DATE/TIME] (→ 38)

[DATE FORMAT] (→ 38)

[POWER SAVE] (→ 92)

[BEEP SOUND] (→ 92)

[LCD SET] (→ 39)

[EVF SET] (→ 39)

[INITIAL SET] (→ 93)

[DEMO MODE] (→ 93)

■ [LANGUAGE] (→ 36)

Still picture recording menus

BASIC	
SCENE MODE	OFF
GUIDE LINES	OFF
PICTURE SIZE	[8.2M]
PICT.QUALITY	■
CLOCK SET	NO
SETUP +> ENTER	EXIT (EXIT)

■ [BASIC]

[SCENE MODE] (→ 54)

[GUIDE LINES] (→ 52)

[PICTURE SIZE] (→ 46)

[PICT.QUALITY] (→ 47)

[CLOCK SET] (→ 38)

■ [ADVANCED]

[O.I.S.] (→ 53)

[SHTR EFFECT] (→ 46)

■ [SETUP]

[DISPLAY] (→ 92)

[DATE/TIME] (→ 38)

[DATE FORMAT] (→ 38)

[FORMAT CARD] (→ 76)

[POWER SAVE] (→ 92)

[BEEP SOUND] (→ 92)

[LCD SET] (→ 39)

[EVF SET] (→ 39)

[INITIAL SET] (→ 93)

[DEMO MODE] (→ 93)

■ [LANGUAGE] (→ 36)

Motion picture playback menus

PLAY SETUP	
PLAY MODE	VIEW ALL
RESUME PLAY	OFF
PLAYLIST	CREATE
SETUP +> ENTER	EXIT (EXIT)

■ [PLAY SETUP]

[PLAY MODE] (→ 61)

[RESUME PLAY] (→ 61)

[PLAYLIST] (→ 66, 67)

■ [EDIT SCENE]

[DIVIDE] (→ 65)

[COMBINE] (→ 65)

[DELETE] (→ 64)

- [DISC SETUP]
- [FINALIZE] (→ 74)
- [UN-FINALIZE] (→ 75)
- [DISC PROTECT] (→ 75)
- [FORMAT DISC] (→ 75)
- [INFORMATION] (→ 76)

- [SETUP]
- [DISPLAY] (→ 92)
- [DATE/TIME] (→ 38)
- [DATE FORMAT] (→ 38)
- [POWER SAVE] (→ 92)
- [BEEP SOUND] (→ 92)
- [LCD SET] (→ 39)
- [EVF SET] (→ 39)
- [TV ASPECT] (→ 78)

■ [LANGUAGE] (→ 36)

(In playlist playback mode)

- [EDIT]
- [ADD] (→ 68)
- [MOVE] (→ 69)
- [DIVIDE] (→ 69)
- [COMBINE] (→ 70)
- [DELETE] (→ 68)
- [CREATE]
- [PLAYLIST VIEW]
- [END]

 Still picture playback menus

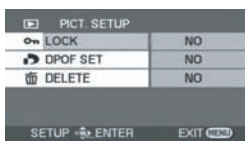

- [PICT. SETUP]
- [LOCK] (→ 72)
- [DPOF SET] (→ 72)
- [DELETE] (→ 71)

- [SETUP]
- [DISPLAY] (→ 92)
- [DATE/TIME] (→ 38)
- [DATE FORMAT] (→ 38)
- [FORMAT CARD] (→ 76)
- [POWER SAVE] (→ 92)
- [BEEP SOUND] (→ 92)
- [LCD SET] (→ 39)

- [EVF SET] (→ 39)
- [TV ASPECT] (→ 78)

■ [LANGUAGE] (→ 36)

Other menus

- [DISPLAY]
- [OFF] • [ON]

The screen indications are selected as shown in the illustration below.

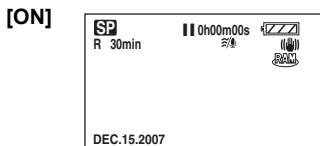
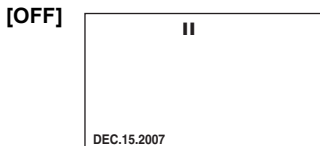

- [POWER SAVE]
- [OFF] • [5 MINUTES]

[OFF]:
The power saving function is not activated.

[5 MINUTES]:
When about 5 minutes have passed without any operation, this unit automatically turns off to prevent the battery from running down. When you use this unit, turn it on again.

- In the following cases, the unit may not turn off even when you set this to [5 MINUTES].
 - When using the AC adaptor
 - When connecting the unit to a computer or printer via the USB cable

- [BEEP SOUND]
- [OFF] • [ON]

This allows operations such as starting and ending recording to be signaled by a beep. When [OFF] is set, no beep is heard when an operation such as recording is started or ended.

- 1 Beep
- When you start recording
- When you turn on the power

When this unit is recognized by the computer or the printer, etc.

2 Beeps

When you pause recording

When you turn off the power

2 Beeps for 4 times

When an error occurs e.g. recording not starting.

Check the sentence displayed on the screen.

(→ 96)

■ [INITIAL SET]



- [YES]
- [NO]

When there is a menu that cannot be selected due another function or mode being activated, set to [YES] for changing the menu settings back to the initial shipping condition.

(The language setting cannot be changed back to the initial shipping condition.)

■ [DEMO MODE]

- [OFF]
- [ON]

This item is used to start the unit demonstration. (Only when using the AC adaptor and the mode dial is at the  or  position)

If you set this to [ON] without inserting a disc or an SD card, this unit is automatically set to the demonstration mode for introducing its functions. If any button is pressed or operated, the demonstration mode is canceled. If no operations take place for approx. 10 minutes, the demonstration mode automatically starts. To terminate the demonstration mode, insert a disc or an SD card, or set this to [OFF]. For normal use, set this function to [OFF].

Indications

Indications



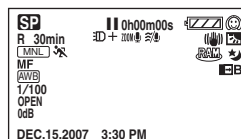

■ Recording indications

Motion picture recording

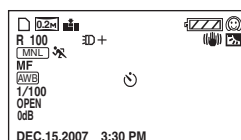

Still picture recording



	Remaining battery power
R 0min	Remaining time for recording
0h00m00s	Elapsed recording time
DEC.15.2007 3:30 PM	Date/time indication
●/II (Red)	Recording/writing to a disc
II (Green)	Recording pause
WIDE	Wide mode
AUTO	Auto mode
MNL	Manual mode
MF	Manual focus
2×	Zoom magnification indication
	Back light mode
	Image stabilizer
1/100	Shutter speed
OPEN, F2.0	F number
0dB	Gain value
	Soft skin mode
W, B	Fade (White), Fade (Black)
	MagicPix function
LD	Video light
ZOOM	Zoom microphone

	Wind noise reduction
XP , SP , LP	Motion picture recording mode
 	Sports mode Portrait mode Low light mode Spotlight mode Surf & snow mode
AWB 	Auto white balance Indoor mode (recording under incandescent lamp) Outdoor mode Manual adjustment mode
 	Disc type DVD-RAM DVD-RW (VR format) DVD-RW (Video format) DVD-RW (unformatted) DVD-R DVD-R DL
	Self-Timer recording
 0.3M 0.2M	Number of recording pixels for still pictures 640×480 640×360
(White) (Green) (Red)	Card can be recorded to Recognizing the card Recording/accessing the card
	Still picture quality
R 100	Remaining number of still pictures

■ Playback indications



Motion picture playback



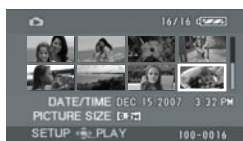



Still picture playback



	Playback
	Pause
	Fast forward/rewind
	Last/first scene paused
	Skip playback
	Slow motion playback
	Frame-by-frame playback
0h00m00s	Motion picture playback time
ALL	Play mode All scenes on the disc displayed
DATE 01	Scenes recorded on the selected date displayed
PL 01	Scenes in the selected playlist displayed
No.10	Scene number
	Volume adjustment
R	Resume playback
	Contents that have been protected on another device
100-0001	Still picture folder/file number display
PictBridge	When a printer compatible with PictBridge is connected
	Accessing the card (When connected to a computer)
D 1	DPOF already set (to more than 1)

	Locked still pictures
 	Number of recording pixels for still pictures 640×480 640×360
The picture size is not displayed for still pictures recorded with other products that have different picture sizes from the sizes shown above.	

■ Confirmatory indications

-- (Time display)	The built-in battery is low. (→ 38)
	The warning/alarm indication appears when LCD monitor is rotated towards the lens side. Return the direction of the LCD monitor to normal position and check the warning/alarm indication.
	No disc is inserted.
	Unusable disc
	No SD card is inserted/ unusable card.

Messages

CANNOT READ THIS DISC. PLEASE CHECK FOR SCRATCHES OR STAINS ON DISC.	The disc is scratched or dirty. Eject the disc and clean it. (→ 24) If there are scratches on the disc, use a new disc.
NO DATA.	There are no images recorded on the disc or card.
THIS DISC IS INCOMPATIBLE.	You inserted an incompatible disc (copy-protected discs, etc.).
PLEASE CHECK THE DISC.	You inserted a disc that cannot be read on this unit (a disc recorded in an incompatible data format etc.).
RECOMMENDED TO USE PANASONIC DISC	You inserted a disc that does not meet the DVD standard for quality and performance so you may not be able to record normally. Refer to the following support site for information about discs that have been confirmed as compatible by Panasonic. http://panasonic.co.jp/pavc/global/cs/e_cam (This website is in English only.)
CANNOT RECORD. (THIS DISC IS FINALIZED)	A finalized DVD-RW (Video format) or DVD-R has been inserted. After finalizing, the discs become play-only and cannot record. If you un-finalize a DVD-RW (Video format), it can be used for recording. (→ 75)
CANNOT RECORD. DISC IS FULL.	The disc is full or the number of scenes has reached the maximum limit so no further data can be recorded. Delete unnecessary scenes (→ 64) or insert a new disc.
CANNOT RECORD. THE NUMBER OF SCENES HAS EXCEEDED THE MAXIMUM LIMIT.	
CANNOT OPERATE. TEMPERATURE IS HIGH. PLEASE TURN OFF AND WAIT A WHILE.	The temperature of the unit is high so it cannot be operated. Turn off the power, wait until the unit cools and then turn on the power again.
FINALIZE THE DISC TO ENABLE PLAYBACK ON OTHER DEVICES.	If you insert a DVD-RW or a DVD-R disc recorded in this unit (that has not been finalized) into another device such as DVD recorder, computer, etc., the disc may become unusable. Be sure to finalize the disc on this unit before inserting it in other devices.
CANNOT UN-FINALIZE THIS DISC.	DVD-R cannot be un-finalized.
CHECK CARD.	This card is not compatible or it cannot be recognized by the unit.
CARD LOCKED.	The write protection switch on the SD card is set to LOCK. (→ 23)

CARD FULL.	The SD card is full so no further data can be recorded. Delete unnecessary files (→ 71) or insert a new SD card.
PUSH THE RESET SWITCH.	An irregularity in the unit has been detected. Press the RESET button to restart the unit. (→ 103)
CHECK THE DISC AFTER PUSHING THE RESET SWITCH TO REPAIR THE DATA.	
CHANGE TO MANUAL MODE.	
CANCEL MAGICPIX MODE.	You are attempting to use a function that cannot be used simultaneously.
TURN OFF THE VIDEO LIGHT.	
CANNOT SET.	With DVD-RW (Video format) and DVD-R, if the number of dates displayed becomes 99 when [PLAY MODE] is set to [BY DATE], you cannot change the aspect setting from 16:9 to 4:3 and vice versa.
PLEASE CONNECT AC ADAPTOR	Finalizations cannot be executed and the unit cannot be connected to the computer when using a battery. Use the AC adaptor.
DISCONNECT USB CABLE.	The unit cannot correctly establish the connection to the computer or printer. Disconnect and reconnect the USB cable and then select the desired USB function again.
CANNOT OPERATE WHILE CONNECTED TO COMPUTER.	The unit's power cannot be turned off when the unit is connected to the computer.

About recovery

It is possible that the system cannot complete writing of a file normally when, for example, power is turned off for some reason during recording or editing.

If faulty management information is found when a disc is accessed, the following message may appear. Be sure to follow the messages. (Repairing may take time depending on the error.)

DISC ERROR HAS OCCURRED. NOW REPAIRING DATA ON THE DISC.

- When you repair the disc, use a battery with sufficient battery power or the AC adaptor. Even if the power is turned off without repairing the disc, you can repair the disc when you turn the power on again.
- Depending on the condition of the data, it may not be possible to completely repair the data.
- Do not repair a disc that has been recorded on another device. This may cause the loss of data or the disc.

Functions that cannot be used simultaneously

Some functions in this unit are disabled or cannot be selected due to the unit's specifications. The table below shows examples of functions restricted by various conditions.

Functions	Conditions which disable the functions
Digital zoom	<ul style="list-style-type: none"> • In picture recording mode
Fade	
MagicPix	<ul style="list-style-type: none"> • While recording to a disc (Cannot set or cancel) • In picture recording mode • When the video light is on (gain up mode)
Backlight compensation	<ul style="list-style-type: none"> • When the MagicPix function is used • When the video light is on (gain up mode) • When the iris/gain is set
Soft skin mode (Set and cancel)	<ul style="list-style-type: none"> • While recording to a disc
Help mode	
Video light on (gain up mode)	<ul style="list-style-type: none"> • When the MagicPix function is used.
Scene mode	<ul style="list-style-type: none"> • When setting the AUTO/MANUAL/FOCUS switch to AUTO • When the MagicPix function is used • When the video light is on
Change of white balance	<ul style="list-style-type: none"> • When digital zoom is used • When the MagicPix function is used • When the video light is on (gain up mode)
Adjusting the shutter speed, iris/gain	<ul style="list-style-type: none"> • When the MagicPix function is used • When the video light is on (gain up mode) • When the scene mode is used

Frequently asked questions

? What kind of discs can be used?

 DVD-RAM, DVD-RW, DVD-R and DVD-R DL can be used if they are 8 cm (3") non-cartridge discs. (→ 19)

? Can discs with a cartridge be used?

 They can be used if the cartridge is removed.

? Can double sided discs be used?

 They can be used.
However you cannot record or play continuously from one side of the disc to the other.
You will need to eject the disc and turn it over.

? Can I record continuously from one side of the disc to the other on a double sided disc?

 You cannot record continuously from one side of the disc to the other. The recording time indicated on the disc package is the total time for both sides. You will need to eject the disc and turn it over to record on both sides.

? Can DVD-R be recorded to once only?



 Recording can be started and stopped until the disc is full.
However the data recorded on the DVD-R cannot be erased.

? Is playback possible on a DVD player?

 By finalizing a DVD-RW (VR format/Video format) or a DVD-R in this unit, it can be played back on a DVD player.
To playback a DVD-RAM, DVD-RW (VR format) or DVD-R DL, you will need a DVD recorder or a DVD player that supports DVD-RAM, DVD-RW (VR format) or DVD-R DL.
Refer to the operating instructions of the DVD recorder or DVD player.

Troubleshooting

Problem	Check points
<p>This unit cannot be turned on.</p>	<ul style="list-style-type: none"> ● Is the battery fully charged? → Charge the battery using the AC adaptor. (→ 25) ● The battery protection circuit may have operated. Attach the battery to the AC adaptor for 5 to 10 seconds. If the unit still cannot be used, the battery is faulty. ● Is the LCD monitor opened or the viewfinder extended?
<p>This unit is turned off automatically.</p>	<ul style="list-style-type: none"> ● If you do not use the unit for approximately 5 minutes, the power is automatically turned off to conserve the battery charge. To resume recording, turn the power back on. The power will not turn off automatically when the power save function (→ 92) is set to [OFF].
<p>This unit does not stay on long enough.</p>	<ul style="list-style-type: none"> ● Is the battery low? → If the remaining battery power indication is flashing or the message "LOW BATTERY." is displayed, the battery has run down. Charge the battery. (→ 25)
<p>A clicking sound is heard when the power is turned off.</p>	<ul style="list-style-type: none"> ● This is the sound of the lens moving and is not a malfunction.
<p>Battery runs down quickly.</p>	<ul style="list-style-type: none"> ● Is the battery fully charged? → Charge it with the AC adaptor. (→ 25) ● Are you using the battery in an extremely cold place? → The battery is affected by ambient temperature. In cold places, the operating time of the battery becomes shorter. ● Has the battery worn out? → The battery has a limited life. If the operating time is still too short even after the battery is fully charged, the battery has worn out and can no longer be used.
<p>This unit cannot be operated though it is turned on.</p> <p>This unit does not operate normally.</p>	<ul style="list-style-type: none"> ● The unit cannot be operated unless you open the LCD monitor or extend the viewfinder. ● Press the RESET button. (→ 103) If normal conditions are not restored yet, remove the battery or AC adaptor, wait about 1 minute and then reconnect the battery or AC adaptor. Then about 1 minute later, turn on the power again. (Conducting the above operation when the access lamp is on may destroy the data on the disc or card.)
<p>The screen has changed suddenly.</p>	<ul style="list-style-type: none"> ● Has the demonstration started? → If you set [DEMO MODE] to [ON] without inserting a disc or a card in video recording mode or picture recording mode, the unit is automatically set to the demonstration mode for introducing its functions. Normally this should be set to [OFF]. Press the MENU button, then select [SETUP] → [DEMO MODE] → [OFF] and press the joystick.

Problem	Check points
The DISC EJECT lever does not work.	<ul style="list-style-type: none"> ● The disc cover will not open unless the unit is powered. → Connect a charged battery or AC adaptor. ● The DISC EJECT lever does not work when the unit is connected to the computer. (→ 104)
The disc cannot be read.	<ul style="list-style-type: none"> ● Are there fingerprints or dirt on the surface of the disc? → If there are fingerprints or dirt on the disc, wipe them off. (→ 24)
A function indication such as the remaining time indication or the elapsed time indication is not shown.	<ul style="list-style-type: none"> ● If you set [SETUP]→[DISPLAY]→[OFF], indications other than warnings and date indications disappear.
Recording does not start although power is supplied to this unit and the disc or card is correctly inserted.	<ul style="list-style-type: none"> ● Is the DVD-RAM or the DVD-RW (VR format) write-protected? → Release the protection. (→ 75) If the DVD-RAM or DVD-RW (VR format) was protected on another device, release the protection on the same device. ● Has the DVD-RW (Video format) or DVD-R been finalized? → After finalizing, the discs become play-only and cannot record. If you un-finalize a DVD-RW (Video format), it can be used for recording. (→ 75) ● Has the SD card's write protect switch been set to LOCK? → No recording is possible while the write protect switch is set to LOCK. (→ 23) ● Is the memory of the disc or card full? → If the disc or card has no more available memory, free up some memory by deleting unnecessary scenes (→ 64, 71) or use a new disc or card. ● Is the unit set to the video recording mode or picture recording mode? → No recording is possible unless the mode dial is at  or . ● Is the disc cover open? → If the cover is open, this unit may not operate normally. Close the disc cover.
Recording starts but stops immediately. The playback picture breaks up for a moment.	<ul style="list-style-type: none"> ● Is the disc scratched or dirty? → Clean the disc. (→ 24) If there are scratches on the disc, use a new disc. ● The unit is hot. Follow the messages on the display. To use the unit again, turn the unit off and leave it for a while.
Recorded still pictures are not clear.	<ul style="list-style-type: none"> ● Are you trying to record small or finely detailed objects with [PICT.QUALITY] set at []? → If you try to record small or finely detailed objects with [PICT.QUALITY] set at [], the images may break up into a mosaic-like pattern. Record with [PICT.QUALITY] set at [] instead. (→ 47)

Problem	Check points
Auto focus function does not work.	<ul style="list-style-type: none"> ● Is manual focus mode selected? → Set the AUTO/MANUAL/FOCUS switch to AUTO. ● Are you trying to record a scene which is hard to bring into focus in auto focus mode? → There are some recording subjects and surroundings for which the auto focus does not operate correctly. (→ 109) If so, use the manual focus mode to adjust the focus. (→ 55)
Sound is not played back from the built-in speaker of this unit.	<ul style="list-style-type: none"> ● Is the volume too low? → During playback, move the volume lever to display the volume indication and adjust it. (→ 60)
Although this unit is correctly connected to a TV, playback images cannot be seen. The playback images are squeezed horizontally.	<ul style="list-style-type: none"> ● Have you selected video input on the TV? → Please read the operating instructions of your TV and select the channel that matches the input used for the connection. ● Is the [TV ASPECT] setting correct? → Change the setting to match the aspect ratio of the TV. Press the MENU button, then select [SETUP] → [TV ASPECT] → [16:9] or [4:3] and press the joystick.
Scenes cannot be deleted or edited.	<ul style="list-style-type: none"> ● Is the DVD-RAM or the DVD-RW (VR format) write-protected? → Release the protection. (→ 75) If the disc or the contents on the disc have been protected on another device, release the protection on the same device. ● It may not be possible to delete scenes that have been divided. → Combine the divided scenes, and then delete them. (→ 65) ● It may not be possible to delete scenes that are displayed as [?!] on the thumbnail display. If the scenes are unnecessary, format the disc or card to erase the data. (→ 75, 76) Please be aware that if a disc or card is formatted then all the data recorded on the disc or card will be erased. ● Is the file on the SD card locked? → Locked files cannot be deleted. Release the lock setting. (→ 72) ● If the SD card's write protect switch is set to LOCK, then deletion is disabled. (→ 23)
The images on the SD card do not look normal.	<ul style="list-style-type: none"> ● The data may be destroyed. It may have been destroyed by static or electromagnetic waves. Store important data on a computer or other products as well.
Even if a disc or a card is formatted, it cannot be used.	<ul style="list-style-type: none"> ● Either this unit or the disc or card may be damaged. Please consult a dealer. Use an SD card from 8 MB to 4 GB with this unit.

Problem	Check points
<p>The indication disappears.</p> <p>The screen is frozen.</p> <p>No operation can be performed.</p>	<ul style="list-style-type: none"> ● Is this unit connected to a computer? → No operation can be performed on this unit when it is connected to a computer. ● Turn off the power to this unit. If the power cannot be turned off, press the RESET button, or remove the battery or AC adaptor and then reattach it. After that, turn on the power again. If normal operation is still not restored, detach the power connected, and consult the dealer who you purchased this unit from.
<p>“PUSH THE RESET SWITCH.” or “CHECK THE DISC AFTER PUSHING THE RESET SWITCH TO REPAIR THE DATA.” is displayed.</p>	<ul style="list-style-type: none"> ● Is the disc scratched or dirty? → After using the following method to restart the unit, eject the disc and clean it. (→ 24) If there are scratches on the disc, use a new disc. ● The unit has automatically detected an error. Press the RESET button with the projecting part of the lens cap A. This will restart the unit. <div data-bbox="510 641 924 803" style="text-align: center;"> <p>The diagram shows a top-down view of the camera's lens assembly. A circular lens cap is shown with a small protrusion labeled 'A'. A line points from this protrusion to a small circular button on the camera body labeled 'RESET'. Another line points from the lens cap to a circular opening on the camera body labeled 'L'.</p> </div> <ul style="list-style-type: none"> ● If you do not press the RESET button, the power to this unit is turned off automatically about 1 minute later. ● Even after you press the RESET button, the indication may still appear repeatedly. If so, this unit needs repair. Detach the power connected, and consult the dealer who you purchased this unit from. Do not attempt to repair the appliance by yourself.
<p>If the SD card is inserted in another device, it is not recognized.</p>	<ul style="list-style-type: none"> ● Check that the device is compatible with the capacity or type of SD card (SD Memory Card/SDHC Memory Card) that you inserted. → Refer to the operating instructions of the device for details.

With a computer

Problem	Check points
<p>Even if connected by the USB cable, this unit is not recognized by the computer.</p>	<ul style="list-style-type: none"> ● The USB function selection screen does not appear if the USB cable is connected while the menu screen is displayed. → Close the menu screen before connecting the USB cable. ● Is the AC adaptor connected? → Use the AC adaptor when connecting the unit and a computer. ● Select another USB terminal on the computer. ● Check the operating environment. (→ 83) ● Turn the unit off then on and disconnect then reconnect the USB cable.

Problem	Check points
<p>The DISC EJECT lever does not work when the unit is connected to the computer.</p>	<ul style="list-style-type: none"> ● The DISC EJECT lever does not work after the unit is connected to the computer. → Use Windows Explorer to right-click the drive icon and execute [Eject]. Or use the software's eject button to eject the disc.
<p>Cannot write to DVD-RAM. Cannot format a disc with the DVD-RAM Driver.</p>	<ul style="list-style-type: none"> ● (Windows XP only) Deleting the unit name from the Device Manager and then connecting the unit and the computer again can improve this. Follow the steps below. Before proceeding, be sure to remove the disc from the unit. <ol style="list-style-type: none"> 1) Select [start] → ([Settings] →) [Control Panel] → ([Performance and Maintenance] →) [System]. 2) Click the [Hardware] tab, then click [Device Manager]. 3) Right click [MATSHITA DVD-RAM LMXK1987 USB Device] displayed at [DVD/CD-ROM drives] and then select [Uninstall]. 4) When erasing is complete, reboot the computer. The computer will automatically recognize the unit again.
<p>When the USB cable is disconnected, an error message will appear on the computer.</p>	<ul style="list-style-type: none"> ● To disconnect the USB cable safely, double-click the  icon in the task tray and follow the instructions on the screen.

Cautions for use

About this unit

- The unit, disc and card become warm after long operation, but this is not a malfunction.

Keep the DVD Video Camera as far away as possible from electromagnetic equipment (such as microwave ovens, TVs, video games etc.).

- If you use the DVD Video Camera on top of or near a TV, the pictures and sound on the DVD Video Camera may be disrupted by electromagnetic wave radiation.
- Do not use the DVD Video Camera near cell phones because doing so may result in noise adversely affecting the pictures and sound.
- Recorded data may be damaged, or pictures may be distorted, by strong magnetic fields created by speakers or large motors.
- Electromagnetic wave radiation generated by microprocessors may adversely affect the DVD Video Camera, disturbing the pictures and sound.
- If the DVD Video Camera is adversely affected by electromagnetic equipment and stops functioning properly, turn the DVD Video Camera off and remove the battery or disconnect AC adaptor. Then reinsert the battery or reconnect AC adaptor and turn the DVD Video Camera on.

Do not use the DVD Video Camera near radio transmitters or high-voltage lines.

- If you record near radio transmitters or high-voltage lines, the recorded pictures and sound may be adversely affected.

Make sure to use the supplied cords and cables. If you use optional accessories, use the cords and the cables supplied with them. Do not extend the cords and the cables.

Do not spray insecticides or volatile chemicals onto the unit.

- If the unit is sprayed with such chemicals, its body may be marred and the surface finish may peel off.

- Do not leave rubber or plastic products in contact with the unit for a long time.

When you use the unit in a sandy or dusty place such as a beach, do not let sand or fine dust get into the body and terminals of the unit.

Also, keep the unit away from sea water.

- Sand or dust may damage the unit. (Care should be taken when inserting and removing a disc or a card.)
- If sea water splashes onto the unit, wipe off the water with a well wrung cloth. Then wipe the unit again with a dry cloth.

When carrying the unit, do not drop or bump it.

- A strong impact can break the unit's casing, causing it to malfunction.

Do not use benzene, paint thinner or alcohol for cleaning the unit.

- Before cleaning, detach the battery or pull out the AC cable from the AC outlet.
- The camera body may be discolored and the surface finish may peel off.
- Wipe the unit with a soft dry cloth to remove dust and fingerprints. To remove stubborn stains, thoroughly wring a cloth that has been soaked in a neutral detergent diluted with water and wipe the unit with it. Afterwards, wipe it with a dry cloth.
- When you use a chemical dust cloth, follow the instructions that came with the cloth.

Do not touch the laser pickup lens.

- If you touch the laser pickup lens directly it may cause malfunctions.

Do not use any other lens cleaners except a commercial available 8 cm (3") DVD video camera lens cleaner.

- Using any other lens cleaners except the one for 8 cm (3") DVD video camera could cause this unit to malfunction.

Do not use the unit for surveillance purposes or other business uses.

- If you use the unit for a long time, heat will build up inside it and this may cause a malfunction.

- This unit is not intended for industrial use.

When you are not going to use the unit for an extended time

- When storing the unit in a cupboard or cabinet, it is recommended that you place a desiccant (silica gel) in with it.

About the battery

The battery used in this unit is a rechargeable lithium-ion battery. It is susceptible to humidity and temperature and the effect increases the more the temperature rises or falls. In cold areas, the full charge indication may not appear or the low battery indication may appear about 5 minutes after starting use. At high temperatures, the protection function may be triggered, making it impossible to use the unit.

Be sure to detach the battery after use.

- If the battery is left attached, a minute amount of current continues to flow even if the unit's power is off. Keeping the unit in this state may result in over discharge of the battery. This may result in you not being able to use the battery even after it is charged.
- The battery should be stored in the vinyl bag so metal does not come into contact with the terminals.
- The battery should be stored in a cool place free from humidity, with as constant temperature as possible. (Recommended temperature: 15 °C to 25 °C (59 °F to 77 °F), Recommended humidity: 40% to 60%)
- Extremely high temperatures or low temperatures will shorten the life of the battery.
- If the battery is kept in high-temperature, high-humidity, or oily-smoky places, the terminals may rust and cause malfunctions.
- To store the battery for a long period of time, we recommend you charge it once every year and store it again after you have completely used up the charged capacity.
- Dust and other matter attached to the battery terminals should be removed.

Prepare spare batteries when going out for recording.

- Prepare batteries for use up to 3 to 4 times the period during you want to record pictures in. In

cold places such as a ski resort, the period during which you can record pictures is shortened.

- When you travel, do not forget to bring an AC adaptor so that you can recharge the batteries at your destination.

If you drop the battery accidentally, check to see if the terminals are damaged.

- Attaching a battery with damaged terminals can damage the unit or AC adaptor.

Do not throw old battery into fire.

- Heating a battery or throwing it into a fire may result in an explosion.
- If the operating time is very short even after the battery has been recharged, the battery has worn out. Please purchase a new battery.

About the AC adaptor

- If the battery is warm, charging requires more time than normal.
- If the temperature of the battery is extremely high or extremely low, the CHARGE lamp may continue flashing, and the battery may not be charged. Wait until the appropriate temperature is restored before charging the battery again. If the battery still fails to charge, something may be wrong with the battery or AC adaptor. Contact your dealer.
- If you use the AC adaptor near a radio, radio reception may be disturbed. Keep the AC adaptor 1 m (3.3 feet) or more away from the radio.
- When using the AC adaptor, it may generate whirring sounds. However, this is normal.
- After use, be sure to disconnect the AC adaptor. (If it is left connected, a minute amount of current is consumed.)
- Always keep the electrodes of the AC adaptor and battery clean.

Put this unit near the outlet to make it easy for the interrupting device (plug) to reach it.

About the disc

● If there is dust, a scratch, or dirt on disc or if it is warped, the following phenomena may occur:

- Block noise in playback image
- Momentary stop of playback image
- Sound interrupted during playback, or abnormal sound
- Scenes are displayed as [!] on the thumbnail display
- Disc cannot correctly be recognized
- Delay between video and audio

When the access lamp is illuminated (during access to the disc), do not open the disc cover, turn off the power, or cause any vibrations or impacts.



DVD-R/DVD-R DL

- For optimum recording on DVD-R discs, this unit writes control data to a DVD-R used for recording when it is being inserted and ejected. If the disc has no area for control data to be written, recording may not be possible. To prevent this, do not insert a DVD-R which has been recorded on more than 50 times.
- Do not insert a DVD-R recorded on this unit that has not been finalized into a recordable device, such as a DVD recorder. The recorded data may be damaged.

About the SD card

- The memory capacity indicated on the label of an SD card is the total of the capacity for copyright protection and management and the capacity which can be used on the unit, a computer etc.
- During prolonged use, the unit's surfaces and the SD card will heat up slightly. This is normal.

When inserting or removing the SD card, always set the OFF/ON switch to OFF.

While this unit accesses the SD card (while  /  is being displayed/the access lamp is lit), do not remove the SD card, operate the

mode dial, turn off the power or shake or impact the unit.

■ About the miniSD Card

- Be sure to insert miniSD Cards in the dedicated card adaptor before use. Inserting a card in this unit without the adaptor may damage the unit or the card.
- Do not insert an empty card adaptor in this unit. Do not leave the adaptor in this unit while inserting or removing miniSD Cards. This may cause the unit to malfunction.

LCD monitor/viewfinder

- When the LCD monitor gets dirty, wipe it with a dry soft cloth.
- In a place with drastic temperature changes, condensation may form on the LCD monitor. Wipe it with soft dry cloth.
- When the unit has become very cold, for example due to storage in a cold area, its LCD monitor will be slightly darker than usual immediately after the power is turned on. The normal brightness will be restored when the unit's internal temperature rises.

Extremely high precision technology is employed to produce the LCD Monitor screen featuring a total of approximately 123,000 pixels. The result is more than 99.99% effective pixels with a mere 0.01% of the pixels inactive or always lit. However, this is not a malfunction and does not affect the recorded picture.

Extremely high precision technology is employed to produce the viewfinder screen featuring a total of approximately 113,000 pixels. The result is more than 99.99% effective pixels with a mere 0.01% of the pixels inactive or always lit. However, this is not a malfunction and does not affect the recorded picture.

About condensation

When condensation forms on the unit, the lens will cloud up and the unit may not work properly. Make every effort to ensure that condensation does not form. If it does form, take the actions described below.

Causes of condensation

Condensation takes place when the ambient temperature or humidity is changed as follows.

- When this unit is brought inside from the cold (e.g. a ski slope) to a warm room.
- When this unit is moved from an air-conditioned car to outside.
- When a cold room has been warmed up quickly.
- When cool wind from an air conditioner is directly blown onto this unit.
- After summer afternoon showers of rain.
- When this unit is in a very humid place where the air is thick with steam. (e.g. a heated swimming pool)

When this unit is taken to a location with a significant temperature difference such as from a cold place to a hot place.

If, for example, you have used this unit for recording on a ski slope and are taking it into a heated room, place the unit inside a plastic bag, remove as much of the air from inside the bag as possible, then seal the bag. Leave the unit for about an hour in the room so the temperature of the unit is close to the ambient temperature of the room, then use it.

What to do if the lens is fogged up.

Remove the battery or AC adaptor and leave the unit for about 1 hour. When the unit becomes close to the ambient temperature, the fog disappears naturally.

Explanation of terms

Automatic white balance

White balance adjustment recognizes the color of light and adjusts so the white color will become a purer white. The unit determines the hue of light that comes through the lens and white balance sensor, thereby judging the recording condition, and selects the closest hue setting.

This is called automatic white balance adjustment.

However, since the unit only stores white color information under certain light sources, automatic white balance adjustment does not function normally under other light sources.

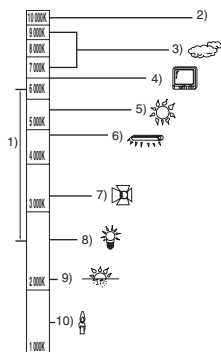

The illustration above shows the range over which the auto white balance functions.

- 1) The effective range of automatic white balance adjustment on this unit
- 2) Blue sky
- 3) Cloudy sky (rain)
- 4) TV screen
- 5) Sunlight
- 6) White fluorescent lamp
- 7) Halogen light bulb
- 8) Incandescent light bulb
- 9) Sunrise or sunset
- 10) Candlelight

Outside of the effective range of automatic white balance adjustment, the image will become reddish or bluish. Even within the effective range of automatic white balance adjustment, the automatic white balance adjustment may not function properly if there is more than one light

source. For light outside the functional automatic white balance adjustment range, use the manual white balance adjustment mode.

White balance

The images recorded by the unit may become bluish or reddish under the influence of certain light sources. To avoid such phenomena, adjust the white balance.

White balance adjustment determines the white color under different light sources. By recognizing which is the white color under sunlight and which is the white color under a fluorescent light, the unit can adjust the balance among the other colors.

Since the white color is the reference for all the colors (that make up light), the unit can record pictures in a natural hue if it can recognize the reference color white.

Auto focus

The lens is moved forward or backward automatically to bring the subject into focus.

Auto focus has the following characteristics.

- Adjusts so that the vertical lines of a subject are seen more clearly.
- Attempts to bring an object with higher contrast into focus.
- Focuses on the screen center only.

Due to these characteristics, auto focus does not work correctly in the following situations. Record pictures in the manual focus mode.

Recording distant and close-up objects at the same time

Since the unit focuses on whatever is at the center of the screen, it is difficult to bring the background into focus when close-up objects are placed in focus. When recording people with distant mountains in the background, you cannot focus on both the subject which is close-up and the objects which are in the distance.

Recording a subject behind a dirty or dusty window

The subject behind the window will not be focused because the focus is on the dirty window.

Similarly, when recording something on the opposite side of a road with heavy traffic, a vehicle that happens to pass by may be brought into focus.

Recording a subject that is surrounded by objects with glossy surfaces or by highly reflective objects

Since whatever is shiny or glistens is brought into focus, it is hard to focus on the subject to be recorded. The focus may become blurry when recording subjects at the beach, at night or in scenes involving fireworks or special lights.

Recording a subject in dark surroundings

The unit cannot focus correctly because the light information that comes through the lens decreases considerably.

Recording a fast-moving subject

As the focus lens-inside moves mechanically, it cannot keep up with a fast-moving subject. When, for example, recording a sports event with fast moving subjects, the focus may lose its sharpness.

Recording a subject with little contrast

It is easy to bring subjects with a sharp contrast or vertical lines or stripes into focus. This means that a subject with little contrast, such as a white wall, may become blurry because the unit achieves focus based upon the vertical lines of an image.

Specifications

DVD Video Camera

Information for your safety

Power source:	DC 7.9 V/7.2 V
Power consumption:	Recording 6.0 W

Signal system	EIA Standard: 525 lines, 60 fields NTSC color signal
Recording format	DVD Video Recording format (DVD-RAM, DVD-RW) DVD-Video format (DVD-RW, DVD-R, DVD-R DL)
Image sensor	1/6" CCD image sensor Total: 680 K Effective pixels: Moving picture: 340 K (4:3), 460 K (16:9) Still picture: 350 K (4:3), 460 K (16:9)
Lens	Auto Iris, F1.8 to F3.7 Focal length: 2.3 mm to 73.6 mm Macro (Full range AF)
Filter diameter	37 mm
Zoom	32× optical zoom, 50/1000× digital zoom
Monitor	2.7" wide LCD monitor (approx. 123 K pixels)
Viewfinder	Color electric viewfinder (approx. 113 K pixels)
Microphone	Stereo (with a zoom function)
Speaker	1 round speaker \varnothing 20 mm
Standard illumination	1,400 lx
Minimum required illumination	12 lx (Low light mode: 1/60) (approx. 2 lx with the MagicPix function)
Video output level	1.0 Vp-p, 75 Ω
S Video output level	Y: 1.0 Vp-p, 75 Ω C: 0.286 Vp-p, 75 Ω
Audio output level (Line)	316 mV, 600 Ω
USB	Card reader/writer function (No copyright protection support) Hi-Speed USB (USB 2.0) compliant PictBridge-compliant
Dimensions (excluding the projecting parts)	66.7 mm (W) × 91.1 mm (H) × 142.7 mm (D) [2.62" (W) × 3.59" (H) × 5.62" (D)]
Mass (without battery, lens cap and a disc)	Approx. 510 g (1.12 lbs.)

Operating temperature	0 °C to 40 °C (32 °F to 104 °F) (0 °C to 30 °C (32 °F to 86 °F) when connected to the computer)
Operating humidity	10% to 80%

Motion pictures

Recording media	8 cm (3") DVD-RAM Ver. 2.1 8 cm (3") DVD-RW Ver. 1.1/2X-SPEED (2X/1X) 8 cm (3") DVD-R for General Ver. 2.0 8 cm (3") DVD-R for DL Ver. 3.0
Compression	MPEG2
Recording mode and transfer rate	XP: 10 Mbps (VBR) (Approx. 18 min recordable time on a single-sided DVD-RAM) SP: 5 Mbps (VBR) (Approx. 37 min recordable time on a single-sided DVD-RAM) LP: 2.5 Mbps (VBR) (Approx. 75 min recordable time on a single-sided DVD-RAM)
Audio compression	Dolby Digital, 16 bit (48 kHz/2 ch)

Still pictures

Recording media	SD Memory Card: 8 MB/16 MB/32 MB/64 MB/128 MB/256 MB/512 MB/1 GB/2 GB (FAT12 and FAT16 format corresponding) SDHC Memory Card: 4 GB (FAT32 format corresponding)
Compression	JPEG (Design rule for Camera File system, based on Exif 2.2 standard), DPOF corresponding
Picture size	640×480, 640×360 (16:9)

AC adaptor





Information for your safety



Power source:	AC 110 V to 240 V, 50/60 Hz
Power consumption:	19 W
DC output:	DC 7.9 V, 1.4 A (Unit operation) DC 8.4 V, 0.65 A (Battery charging)

Dimensions	61 mm (W) × 32 mm (H) × 91 mm (D) [2.40" (W) × 1.26" (H) × 3.58" (D)]
Mass	Approx. 110 g (0.24 lbs.)

Specifications may change without prior notice.











Number of recordable pictures on an SD card

Picture size	0.3m (640×480)		0.2m (640×360)	
				
8 MB	42	86	42	86
16 MB	97	195	97	195
32 MB	210	420	210	420
64 MB	430	870	430	870
128 MB	820	1650	820	1650
256 MB	1710	3430	1710	3430
512 MB	3400	6790	3400	6790
1 GB	6800	13600	6800	13600
2 GB	13830	27660	13830	27660
4 GB	27150	54310	27150	54310

- The number of recordable pictures depends on whether [] and [] are used together and on the subject being recorded.
- The numbers shown in the table are approximations.

Optional accessories

Some optional accessories may not be available in some countries.

Accessory No.	Figure	Description
LM-AF30U		8 cm (3") DVD-RAM (single sided)
LM-AF60U		8 cm (3") DVD-RAM (double sided)
LM-RW30U		8 cm (3") DVD-RW (single sided)
LM-RW60U		8 cm (3") DVD-RW (double sided)
LM-RF30V		8 cm (3") DVD-R (single sided)
LM-RF60V		8 cm (3") DVD-R (double sided)
LM-RF55LV		8 cm (3") DVD-R DL (dual layer on single side)
PV-DAC14		AC adaptor with AC Cable and DC Cables
CGR-DU06A/1B*		640 mAh/Rechargeable Lithium Ion Battery Pack
CGA-DU12A/1B*		1150 mAh/Rechargeable Lithium Ion Battery Pack
CGA-DU21A/1B*		2040 mAh/Rechargeable Lithium Ion Battery Pack
RP-SDR04GU1K RP-SDR02GU1A RP-SDR01GU1A RP-SDR512U1A RP-SDR256U1A		Class 2 4 GB SDHC Memory Card Class 2 2 GB SD Memory Card Class 2 1 GB SD Memory Card Class 2 512 MB SD Memory Card Class 2 256 MB SD Memory Card
RP-SDK02GU1A RP-SDH01GU1A RP-SDK512U1A RP-SDH256U1A		High Speed 2 GB SD Memory Card High Speed 1 GB SD Memory Card High Speed 512 MB SD Memory Card High Speed 256 MB SD Memory Card
RP-SDV04GU1K RP-SDV02GU1A RP-SDV01GU1A		Class 6 4 GB SDHC Memory Card Class 6 2 GB SD Memory Card Class 6 1 GB SD Memory Card
RP-SS01GU1K RP-SS512BU1K RP-SS256BU1K		miniSD 1 GB SD Memory Card miniSD 512 MB SD Memory Card miniSD 256 MB SD Memory Card
VW-LDC10		

* Please refer to page 26 concerning the battery charging time and available recording time.

NOTE: Accessories and/or model numbers may vary by country. Please consult your local dealer.

Accessory Order Form (For USA Customers)

Please photocopy this form when placing an order.

1. Model # _____
 2. Items Ordered _____

Accessory #	Description	Price Each	Quantity	Total Price
Subtotal				
Your State & Local Sales Tax				
Shipping & Handling				6.95
Total Enclosed				

3. Method of payment (check one)

- Check of Money Order enclosed (NO C.O.D.SHIPMENTS)
 VISA Credit Card # _____
 MasterCard Expiration Date _____
 Discover Customer Signature _____

Make Check or Money Order Payable to: PANASONIC ACCESSORIES

(Please do not send cash)

4. Shipping information (UPS delivery requires complete street address)

Ship To:
 Mr. _____
 Mrs. _____
 Ms. _____

First Last Phone#:

Day () _____

Street Address _____

Night () _____

City State Zip

TO OBTAIN ANY OF OUR ACCESSORIES YOU CAN DO ANY OF THE FOLLOWING:
 VISIT YOUR LOCAL PANASONIC DEALER
 OR
 CALL PANASONIC'S ACCESSORY ORDER LINE AT 1-800-332-5368
 [6 AM-6 PM M-F, PACIFIC TIME]
 OR
 MAIL THIS ORDER TO: PANASONIC SERVICES COMPANY ACCESSORY ORDER OFFICE
 20421 84th Avenue South Kent, WA. 98032

In CANADA, please contact your local Panasonic dealer for more information on Accessories.

Request for Service Notice (USA Only)

Please photocopy this form when making a request for service notice, in the unlikely event this product needs service.

Request for Service Notice:

- Please include your **proof of purchase**.
(Failure to do so will delay your repair.)
 - To further speed your repair, please provide an explanation of what is wrong with the unit and any symptom it is exhibiting.
-
-
-
-

Mail this completed form and your Proof of Purchase along with your unit to:
Panasonic Camera and Digital Service Center
1590 Touhy Ave.
Elk Grove Village, IL 60007

Limited Warranty (For USA Customers)

PANASONIC CONSUMER ELECTRONICS COMPANY, DIVISION OF PANASONIC CORPORATION OF NORTH AMERICA
 One Panasonic Way, Secaucus, New Jersey 07094

PANASONIC PUERTO RICO, INC.
 Ave. 65 de Infantería, Km. 9.5 San Gabriel Industrial Park,
 Carolina, Puerto Rico 00985

Panasonic Video Products Limited Warranty

Limited Warranty Coverage

If your product does not work properly because of a defect in materials or workmanship, Panasonic Consumer Electronics Company or Panasonic Puerto Rico, Inc. (collectively referred to as "the warrantor") will, for the length of the period indicated on the chart below, which starts with the date of original purchase ("warranty period"), at its option either (a) repair your product with new or refurbished parts, or (b) replace it with a new or a refurbished product. The decision to repair or replace will be made by the warrantor.

Product	Parts	Labor	Service	Contact Number
Camcorder	One (1) Year (except CCD Image Sensor) CCD Image Sensor - 6 (Six) Months	Ninety (90) Days Ninety (90) Days	Carry-In or Mail-In	1-800-211-PANA(7262)
DVD/VCR Deck, A/V Mixer	One (1) Year	Ninety (90) Days	Carry-In or Mail-In	1-800-211-PANA(7262)
TV/VCR, TV/DVD, TV/DVD/VCR Combination	One (1) Year (except CRT) CRT - Two (2) Years	Ninety (90) Days Ninety (90) Days	Carry-In: 21" CRT and Smaller In-Home or Carry-In: 22" CRT and Larger	1-800-211-PANA(7262)
TV/HDR Combination	One (1) Year (except CRT) CRT - Two (2) Years	Ninety (90) Days Ninety (90) Days	In-Home or Carry-In	1-888-843-9788
Rechargeable Batteries (in exchange for defective item)	Ten (10) Days	Not Applicable	Carry-In or Mail-In	1-800-211-PANA(7262)
Tape (in exchange for defective item)	Five (5) Days	Not Applicable	Carry-In or Mail-In	1-800-211-PANA(7262)
Memory Cards (in exchange for defective item)	Ninety (90) Days	Not Applicable	Carry-In or Mail-In	1-800-211-PANA(7262)

During the "Labor" warranty period there will be no charge for labor. During the "Parts" warranty period, there will be no charge for parts. You must carry-in or mail-in (prepaid) your product or arrange for in-home service, as applicable, during the warranty period. If non-rechargeable batteries are included, they are not warranted. This warranty only applies to products purchased and serviced in the United States or Puerto Rico. This warranty is extended only to the original purchaser of a new product which was not sold "as is". A purchase receipt or other proof of the original purchase date is required for warranty service.

Carry-in, Mail-in (Prepaid) or In-Home Service

For Carry-in, Mail-in (prepaid) or In-Home Service (as applicable) in the United States call toll free contact number listed above or visit Panasonic Web Site: <http://www.panasonic.com>

For assistance in Puerto Rico call Panasonic Puerto Rico, Inc. (787)-750-4300 or fax (787)-768-2910.

In-Home service, if applicable, requires clear, complete and easy access to the product by the authorized servicer and does not include removal or re-installation of an installed product. It is possible that certain in-home repairs will not be completed in-home, but will require that the product, or parts of the product, be removed for shop diagnosis and/or repair and then returned.

Limited Warranty Limits And Exclusions

This warranty ONLY COVERS failures due to defects in materials or workmanship, and DOES NOT COVER normal wear and tear or cosmetic damage, nor does it cover markings or retained images on the picture tube resulting from viewing fixed images (including, among other things, letterbox pictures on standard 4:3 screen TV's, or non-expanded standard 4:3 pictures on wide screen TV's, or onscreen data in a stationary and fixed location). The warranty ALSO DOES NOT COVER damages which occurred in shipment, or failures which are caused by products not supplied by the warrantor, or failures which result from accidents, misuse, abuse, neglect, bug infestation, mishandling, misapplication, alteration, faulty installation, set-up adjustments, misadjustment of consumer controls, improper maintenance, power line surge, lightning damage, modification, or commercial use (such as in a hotel, office, restaurant, or other business), rental use of the product, service by anyone other than a Factory Service Center or other Authorized Servicer, or damage that is attributable to acts of God.

THERE ARE NO EXPRESS WARRANTIES EXCEPT AS LISTED UNDER "LIMITED WARRANTY COVERAGE". THE WARRANTOR IS NOT LIABLE FOR INCIDENTAL OR CONSEQUENTIAL DAMAGES RESULTING FROM THE USE OF THIS PRODUCT, OR ARISING OUT OF ANY BREACH OF THIS WARRANTY.

(As examples, this excludes damages for lost time, cost of having someone remove or re-install an installed unit if applicable, or travel to and from the servicer, loss of media or images, data or other memory or recorded content. The items listed are not exclusive, but are for illustration only.)

ALL EXPRESS AND IMPLIED WARRANTIES, INCLUDING THE WARRANTY OF MERCHANTABILITY, ARE LIMITED TO THE PERIOD OF THE LIMITED WARRANTY.

Some states do not allow the exclusion or limitation of incidental or consequential damages, or limitations on how long an implied warranty lasts, so the exclusions may not apply to you. This warranty gives you specific legal rights and you may also have other rights which vary from state to state. If a problem with this product develops during or after the warranty period, you may contact your dealer or Service Center. If the problem is not handled to your satisfaction, then write to the warrantor's Consumer Affairs Department at the addresses listed for the warrantor.

PARTS AND SERVICE (INCLUDING COST OF AN IN-HOME SERVICE CALL, WHERE APPLICABLE) WHICH ARE NOT COVERED BY THIS LIMITED WARRANTY ARE YOUR RESPONSIBILITY.

Customer Services Directory

Service in Canada: As per Service Center listed in Canadian warranty information → 118

Obtain Product Information and Operating Assistance; locate your nearest Dealer or Service Center; purchase Parts and Accessories; or make Customer Service and Literature requests by visiting our Web Site at:

<http://www.panasonic.com/consumersupport>

or, contact us via the web at:

<http://www.panasonic.com/contactinfo>

You may also contact us directly at:

1-800-211-PANA (7262),

Monday-Friday 9 am-9 pm; Saturday-Sunday 10 am-7 pm, EST

For hearing or speech impaired TTY users, TTY : 1-877-833-8855

Accessory Purchases

Purchase Parts, Accessories and Instruction Books online for all Panasonic Products by visiting our Web Site at:

<http://www.pasc.panasonic.com>

or, send your request by E-mail to:

npcparts@us.panasonic.com

You may also contact us directly at:

1-800-332-5368 (Phone) 1-800-237-9080 (Fax Only) (Monday – Friday 9 am to 9 pm, EST.)

Panasonic Services Company

20421 84th Avenue South,

Kent, WA 98032

(We Accept Visa, MasterCard, Discover Card, American Express, and Personal Checks)

For hearing or speech impaired TTY users, TTY : 1-866-605-1277

Product Repairs

Centralized Factory Service Center

MAIL TO:

Panasonic Camera and Digital Service Center

1590 Touhy Ave.

Elk Grove Village, IL 60007

Please carefully pack and ship, prepaid and insured, to the Elk Grove Village Centralized Factory Service Center

Customer's in Puerto Rico, please ship or carry in to location below ("Service in Puerto Rico").

Service in Puerto Rico

Panasonic Puerto Rico, Inc.

Ave. 65 de Infantería, Km. 9.5, San Gabriel Industrial Park,

Carolina, Puerto Rico 00985

Phone (787)750-4300, Fax (787)768-2910

As of November 2006

Warranty (For Canadian Customers)

Panasonic Canada Inc.

5770 Ambler Drive, Mississauga, Ontario L4W 2T3

PANASONIC PRODUCT – LIMITED WARRANTY

Panasonic Canada Inc. warrants this product to be free from defects in material and workmanship and agrees to remedy any such defect for a period as stated below from the date of original purchase.

Camcorder Product – One (1) year, parts and labour

LIMITATIONS AND EXCLUSIONS

This warranty does not apply to products purchased outside Canada or to any product which has been improperly installed, subjected to usage for which the product was not designed, misused or abused, damaged during shipping, or which has been altered or repaired in any way that affects the reliability or detracts from the performance, nor does it cover any product which is used commercially. Dry cell batteries are also excluded from coverage under this warranty.

This warranty is extended to the original end user purchaser only. A purchase receipt or other proof of date of original purchase is required before warranty service is performed.

THIS EXPRESS, LIMITED WARRANTY IS IN LIEU OF ALL OTHER WARRANTIES, EXPRESS OR IMPLIED, INCLUDING ANY IMPLIED WARRANTIES OF MERCHANTABILITY AND FITNESS FOR A PARTICULAR PURPOSE.

IN NO EVENT WILL PANASONIC CANADA INC. BE LIABLE FOR ANY SPECIAL, INDIRECT OR CONSEQUENTIAL DAMAGES.

In certain instances, some jurisdictions do not allow the exclusion or limitation of incidental or consequential damages, or the exclusion of implied warranties, so the above limitations and exclusions may not be applicable.

WARRANTY SERVICE

FOR PRODUCT OPERATION ASSISTANCE, please contact:

Our Customer Care Centre:	Telephone #:	(905) 624-5505
	1-800 #:	1-800-561-5505
	Fax #:	(905) 238-2360
	Email link:	“Customer support” on www.panasonic.ca

FOR PRODUCT REPAIRS, please locate your nearest Authorized Servicentre at www.panasonic.ca :

Link: “Servicentres™ locator” under “Customer support”

IF YOU SHIP THE PRODUCT TO A SERVICENTRE

Carefully pack and send prepaid, adequately insured and preferably in the original carton.
Include details of the defect claimed, and proof of date of original purchase.

Index

■ A

AC adaptor	25, 28, 106
Aperture	57
Auto focus	109
Automatic white balance	56, 108

■ B

Backlight compensation	50
Battery	25, 26, 106
Beep sound	92

■ C

Card	23, 24, 31, 107
Charging time	26

■ D

Date and time display	38
Delete	
Scene	64
Still picture	71
Demo mode	93
Digital zoom	48
Disc	19, 24, 29, 107
Information	76
Display	92
DPOF setting	72
Dubbing	79, 80
DVD-RAM, DVD-RW, DVD-R, DVD-R DL	19

■ F

Fade	50
Finalize	74
Format	
Card	76
Disc	75
Frame-by-frame playback	60

■ G

Gain	57
Guideline	52

■ H

Help mode	36
-----------	----

■ I

Image stabilizer function	53
Initial setting	93
Iris	57

■ L

Language	36
LCD monitor	18, 39, 107
Locking still pictures	72

■ M

MagicPix function	51
Manual focus	55
Menu	36
Menu list	91
Motion picture playback	59
Motion picture recording	42

■ N

Number of recordable pictures	112
-------------------------------	-----

■ O

Operation icons	34
-----------------	----

■ P

Pickup lens	30
PictBridge	81
Picture quality	47
Picture size	46
Playing back motion pictures by date	61
Playlist	66
Power save	92
Protect (Disc)	75

■ R

Recording mode	43
Recording time elapsed	43
Remaining number of still pictures	46
Remaining time	43
Repair (Disc)	97
Resume playback	61

■ S

Scene mode	54
SD Memory Card	23
SDHC Memory Card	23
Self-recording	49
Self-timer recording	52
Shutter effect	46
Shutter speed	57
Skip playback	59
Slow-motion playback	60
Soft skin mode	51
Still picture compatibility	62
Still picture playback	62
Still picture recording	45

■ T

TV aspect	78
-----------	----

■ U

Un-finalize	75
-------------	----

■ V

Video format	21
Video light	49
Viewfinder	18, 39, 107

Others

Volume adjustment	60
VR format	21
■ W	
White balance	56, 109
Wide mode	53
Wind noise reduction function	54
■ Z	
Zoom	48
Zoom microphone	48

Spanish Quick Use Guide/ Guía española para el uso rápido

■ Carga de la batería

- 1 Conecte el cable eléctrico de CA al adaptador de CA y a la toma de la red de CA.
- 2 Meta la batería en el respectivo soporte alineando la marca, luego encájela.

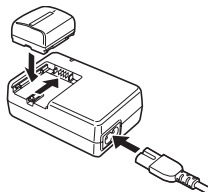

■ Montaje de la batería

Empuje la batería contra el porta batería y hágala deslizar hasta que dispare.

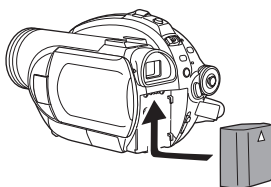

■ Cómo quitar la batería

Mientras hace deslizar la palanca BATTERY, haga deslizar la batería para quitarla.

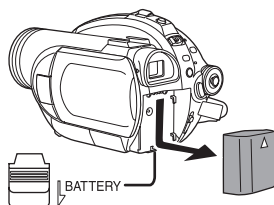

■ Cómo encender/apagar la alimentación

Mientras pulsa el botón A, ajuste el interruptor OFF/ON a ON/OFF.

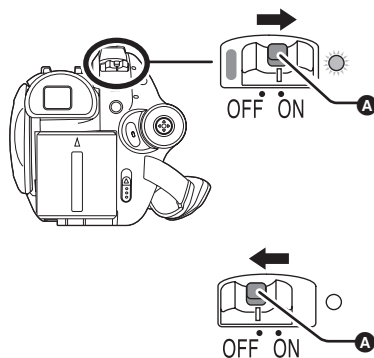

■ Insertar/quitar un disco

- 1 Haga deslizar la palanca DISC EJECT una vez y la deje.

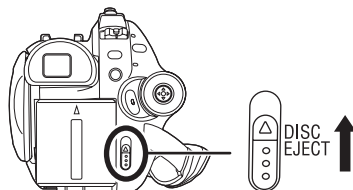

- 2 Abra la tapa del compartimiento del disco manualmente e inserte/saque el disco.

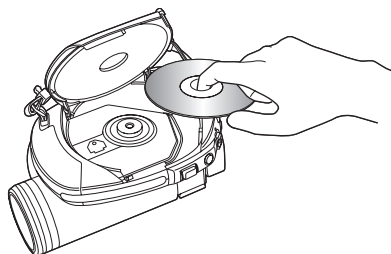

- 3 Empuje la sección marcada PUSH CLOSE en la tapa del compartimiento del disco para cerrarla.

■ Cómo insertar/quitar una tarjeta SD

- 1 Deslice la tapa de la ranura para tarjetas para abrirla.

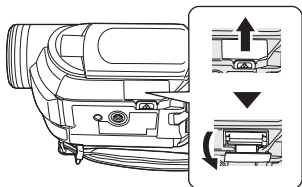

- 2 Inserte/quite la tarjeta SD en/de la ranura de la tarjeta.

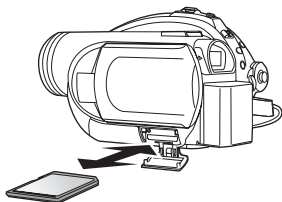

- 3 Cierre firmemente la tapa de la ranura de la tarjeta.

■ Grabación de imágenes dinámicas

- Gire el selector de modo para seleccionar .

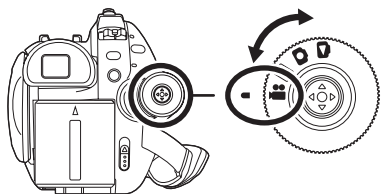

- 1 Pulse el botón de inicio/parada de la grabación para empezar a grabar.

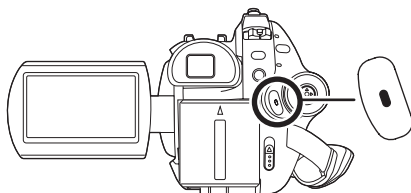

- 2 Pulse de nuevo el botón de inicio/parada de la grabación para detener brevemente la grabación.



■ Grabación de imágenes fijas (imágenes fijas JPEG)

- Gire el selector de modo para seleccionar .

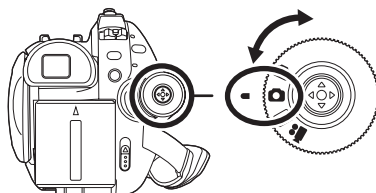

Pulse el botón de toma fotográfica [].

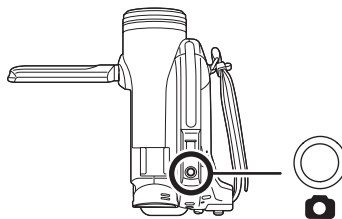

■ Reproducción de imágenes dinámicas

- Gire el selector de modo para seleccionar .

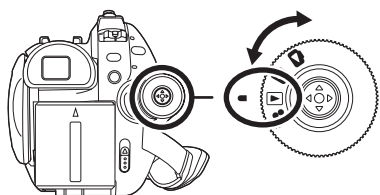

- 1 Seleccione la escena a ser reproducida.

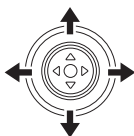

- 2 Pulse el joystick.



- 3 Mueva el joystick para obrar.

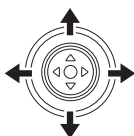

- ▶/||: Reproducción/Pausa
- ◀◀: Salto de reproducción (hacia atrás)
- ▶▶: Salto de reproducción (en adelante)
- : Detiene la reproducción y muestra las miniaturas.

■ Reproducción de imágenes fijas (imágenes fijas JPEG)

- Gire el selector de modo para seleccionar .

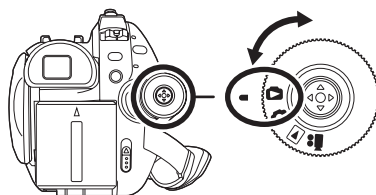

- 1 Seleccione el archivo a ser reproducido.

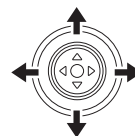
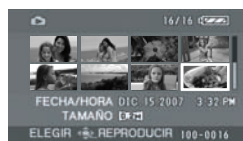

- 2 Pulse el joystick.



- 3 Mueva el joystick para obrar.

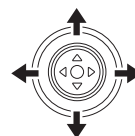

- ▶/||: La exposición de diapositivas inicia/se interrumpe.
- ◀: Reproduce la imagen anterior.
- ▶: Reproduce la imagen siguiente.
- : Detiene la reproducción y muestra las miniaturas.

**Panasonic Consumer Electronics Company,
Division of Panasonic Corporation of North America**

One Panasonic Way, Secaucus, NJ 07094

Panasonic Puerto Rico, Inc.

Ave. 65 de Infantería, Km. 9.5, San Gabriel Industrial Park, Carolina, Puerto Rico 00985

Panasonic Canada Inc.

5770 Ambler Drive, Mississauga, Ontario, L4W 2T3



LSQT1146 A
F1206Mc

